

EDAN Agile PLM Electronic Signature Information

--Signatures related to this document and performed in EDAN Agile PLM.

文件名称(Document Name) : M3 说明书_英文

文件编号(Number) : 01.54.109395

版本(Version) : 2.5

产品型号(Product Model) : M3

项目编码(Project Code) : 2077I000

签批信息(Signature):

作者(Originator) : 吴孝萍 (wuxiaoping) 2019-01-16 15:28:45

审核人(Reviewers) : 史洪华 (shihonghua) 2019-01-16 15:46:10

审核人(Reviewers) : 韦华彪 (weihuabiao) 2019-01-16 15:53:18

审核人(Reviewers) : 王敏 (wangmin) 2019-01-16 15:45:06

审核人(Reviewers) : 陈艳娟 (chenyanjuan) 2019-01-16 16:30:27

审核人(Reviewers) : 王红春 (wanghongchun) 2019-01-16 16:52:54

审核人(Reviewers) : 刘自成 (liuzicheng) 2019-01-16 15:45:52

批准人(Approvers) : 夏欢欢 (xiahuanhuan) 2019-01-16 17:33:59

批准人(Approvers) : 陈浩杰 (chenhaojie) 2019-01-16 17:17:19

M3

Vital Signs Monitor

Version 2.5

User Manual

CE₀₁₂₃



About this Manual

P/N: 01.54.109395

MPN: 01.54.109395025

Release Date: January 2019

© Copyright EDAN INSTRUMENTS, INC. 2008-2019. All rights reserved.

Statement

This manual will help you understand the operation and maintenance of the product better. It is reminded that the product shall be used strictly complying with this manual. User's operation failing to comply with this manual may result in malfunction or accident for which EDAN INSTRUMENTS, INC. (hereinafter called EDAN) cannot be held liable.

EDAN owns the copyrights of this manual. Without prior written consent of EDAN, any materials contained in this manual shall not be photocopied, reproduced or translated into other languages.

Materials protected by the copyright law, including but not limited to confidential information such as technical information and patent information are contained in this manual, the user shall not disclose such information to any irrelevant third party.

The user shall understand that nothing in this manual grants him, expressly or implicitly, any right or license to use any of the intellectual properties of EDAN.

EDAN holds the rights to modify, update, and ultimately explain this manual.

Responsibility of the Manufacturer

EDAN only considers itself responsible for any effect on safety, reliability and performance of the equipment if:

Assembly operations, extensions, re-adjustments, modifications or repairs are carried out by persons authorized by EDAN, and

The electrical installation of the relevant room complies with national standards, and

The instrument is used in accordance with the instructions for use.

Terms Used in this Manual

This guide is designed to give key concepts on safety precautions.

WARNING

A **WARNING** label advises against certain actions or situations that could result in personal injury or death.

CAUTION

A **CAUTION** label advises against actions or situations that could damage equipment, produce inaccurate data, or invalidate a procedure.

NOTE

A **NOTE** provides useful information regarding a function or a procedure.

Table of Contents

Chapter 1 Intended Use and Safety Guidance	1
1.1 Intended Use/Indications for Use.....	1
1.2 Safety Guidance	1
1.2.1 Environment.....	1
1.2.2 Power Source Requirements	1
1.2.3 Grounding the Monitor	1
1.2.4 Equipotential Grounding.....	1
1.2.5 Condensation.....	2
1.2.6 Safety Precautions.....	2
1.2.7 Protecting Personal Information	7
1.2.8 Explanation of Symbols on the Monitor	8
Chapter 2 Installation of Monitor	11
2.1 Opening the Package and Checking.....	11
2.2 Connecting the Power Cable.....	11
2.3 Powering on the Monitor	11
2.4 Connecting Sensor to Patient	12
2.5 Checking the Recorder.....	12
Chapter 3 Introduction.....	13
3.1 General Information	13
3.2 Screen Display	14
3.2.1 General Display Mode	14
3.2.2 Double-Parameter Mode	19
3.2.3 Single Parameter Mode.....	20
3.3 Button Functions	21
3.4 Interfaces.....	23
3.5 Built-in Rechargeable Battery.....	26
3.5.1 Battery Safety Information.....	26
3.5.2 Battery Status on the Main Screen	27
3.5.3 Checking Battery Performance	27
3.5.4 Replacing the Battery	28
3.5.5 Recycling the Battery	28
3.5.6 Maintaining the Battery.....	28
3.5.7 Battery Alarm Information.....	28
Chapter 4 System Menu	29
4.1 Patient Setup	29
4.2 Default Setup.....	29
4.3 System Setup.....	29
4.4 Selection.....	30
4.5 Deleting Data	30

4.6 Version.....	31
4.7 Time Setup	31
4.8 NIBP Setup.....	31
4.9 TEMP Setup	31
4.10 Alarm Setup.....	31
4.11 Maintain	31
4.12 Data Store.....	35
4.13 Sleep Mode	36
Chapter 5 Alarm.....	38
5.1 Alarm Modes	38
5.1.1 Alarm Level.....	38
5.1.2 Alarm Modes	38
5.1.3 Alarm Setup.....	40
5.2 Alarm Cause	40
5.3 Audio Alarm Paused.....	41
5.4 Audio Alarm Off	41
5.5 Alarm Reset.....	42
5.6 Parameter Alarm.....	42
5.7 When an Alarm Occurs	43
5.8 Testing Alarms.....	43
Chapter 6 Trend and Recording	44
6.1 General Information on Recording	44
6.2 Recorder Operations.....	44
6.3 Recorder Alarm Information	45
Chapter 7 Maintenance/Cleaning.....	46
7.1 Inspecting	46
7.2 Maintenance Task and Test Schedule.....	46
7.3 General Cleaning.....	47
7.3.1 Cleaning the Monitor	47
7.3.2 Cleaning the Reusable Accessories	47
7.3.3 Cleaning the Dust-proof Filter Assembly	48
7.4 Disinfection	49
7.4.1 Disinfecting the Monitor	50
7.4.2 Disinfecting the Reusable Accessories	50
7.5 Replacement of Fuse	51
7.6 Cleaning Battery and Battery Compartment Cover	51
Chapter 8 SpO₂ Monitoring (Optional)	52
8.1 Overview	52
8.2 SpO ₂ Safety Information	52
8.3 Measuring SpO ₂	53
8.4 Measurement Limitations	54

8.5 Assessing the Validity of a SpO ₂ Reading.....	55
8.6 SpO ₂ Alarm Delay.....	56
8.7 Perfusion Index (PI)*	56
8.8 SatSeconds Alarm Management*	56
8.8.1 Describing SatSeconds.....	56
8.8.2 SatSeconds “Safety Net”.....	58
8.8.3 Setting SatSeconds Duration.....	58
8.9 Alarm.....	58
8.9.1 Adjustable Range of Alarm Limits.....	58
8.9.2 Alarm Information and Prompts	58
Chapter 9 NIBP Monitoring (Optional)	61
9.1 Overview	61
9.2 NIBP Safety Information	61
9.3 Measurement Limitations	62
9.4 NIBP Monitoring.....	63
9.4.1 Operation Prompts	64
9.4.2 Correcting the Measurement if Limb is not at Heart Level	65
9.5 NIBP Setup.....	65
9.6 Alarm.....	65
9.6.1 Adjustable Range of Alarm Limits.....	65
9.6.2 Alarm Information and Prompts	66
Chapter 10 TEMP Monitoring (Optional)	69
10.1 TEMP Monitoring with T2 Module	69
10.1.1 Introduction	69
10.1.2 Measuring Procedure	70
10.1.3 TEMP Setup for T2 Module.....	71
10.1.4 Alarm.....	71
10.2 TEMP Monitoring with TH Module	73
10.2.1 Introduction	73
10.2.2 Measuring Procedure	74
10.2.3 Alarm.....	76
10.2.4 Replacing the Battery	77
10.3 TEMP Monitoring with F3000 Module	77
10.3.1 General Information	77
10.3.2 Safety Information	78
10.3.3 Probe Covers —Applying & Removing	79
10.3.4 Changing Isolation Chambers and Probes	79
10.3.5 Measuring Mode	80
10.3.6 Measuring Procedure	80
10.3.7 TEMP Setup for F3000 Module.....	82
10.3.8 Alarm.....	82

Chapter 11 Other Functions	85
11.1 Nurse Call.....	85
11.2 Network.....	85
11.3 Central Monitoring System	85
Chapter 12 Accessories	86
Chapter 13 Warranty and Service	90
13.1 Warranty	90
13.2 Contact Information	90
Appendix A Specifications	91
A.1 Classification.....	91
A.2 Specifications	91
A.2.1 Size and Weight.....	91
A.2.2 Function Configuration	91
A.2.3 Environment.....	91
A.2.4 Display	92
A.2.5 Battery	92
A.2.6 Recorder	93
A.2.7 Data Storage	93
A.2.8 NIBP	93
A.2.9 SpO ₂	94
A.2.10 PR.....	96
A.2.11 TEMP	96
Appendix B EMC Information - Guidance and Manufacture’s Declaration	99
B.1 Electromagnetic Emissions	99
B.2 Electromagnetic Immunity	99
B.3 Electromagnetic Immunity	101
B.4 Recommended Separation Distances	103
Appendix C Abbreviation	105

Chapter 1 Intended Use and Safety Guidance

1.1 Intended Use/Indications for Use

The monitor is intended to be used by qualified physicians or personnel professionally trained and it is for monitoring adults, pediatrics and neonates in hospital environments.

This monitor is used to monitor vital signals for patients and is suitable for use in hospital environments including out-patient department, wards and NICU.

Monitored parameters include: NIBP, SpO₂, pulse rate, Quick TEMP/Infrared TEMP.

1.2 Safety Guidance

1.2.1 Environment

Follow the instructions below to ensure completely safe electrical installation. The environment where the monitor will be used should be reasonably free from vibration, dust, corrosive or explosive gases, extremes of temperature, humidity, and so on. For a cabinet mounted installation, allow sufficient room at the front for operation and sufficient room at the rear for servicing with the cabinet access door open.

The monitor operates within specifications at ambient temperatures between 0 °C ~+40 °C. Ambient temperatures that exceed these limits could affect the accuracy of the instrument and cause damage to the modules and circuits. Allow at least 2 inches (5 cm) clearance around the instrument for proper air circulation.

1.2.2 Power Source Requirements

Refer to *Appendix A*.

1.2.3 Grounding the Monitor

To protect the patient and hospital personnel, the cabinet of the monitor must be grounded. Accordingly, the monitor is equipped with a 3-wire cable which grounds the instrument to the power line ground (protective earth) when plugged into an appropriate 3-wire receptacle. If a 3-wire receptacle is not available, consult the hospital electrician.

Connect the grounding wire to the equipotential grounding terminal on the mains system. If it is not evident from the instrument specifications whether a particular instrument combination is hazardous or not, for example due to summation of leakage currents, the user should consult the manufacturers concerned or an expert in the field, to ensure that the necessary safety of all instruments concerned will not be impaired by the proposed combination.

1.2.4 Equipotential Grounding

Protection class 1 instruments are already included in the protective grounding (protective earth) system of the room by way of grounding contacts in the power plug. For internal examinations on the heart or the brain, the Monitor must have a separate connection to the equipotential grounding system. One end of the equipotential grounding cable (potential equalization conductor) is connected to the equipotential grounding terminal on the rear panel of the instrument and the other end to one point of the equipotential grounding system. The equipotential grounding system

assumes the safety function of the protective grounding conductor if ever there is a break in the protective grounding system. Examinations in or on the heart (or brain) should only be carried out in medically used rooms incorporating an equipotential grounding system. Check each time before use that the instrument is in perfect working order. The cable connecting the patient to the instrument must be free of electrolyte.

WARNING

If the protective grounding (protective earth) system is doubtful, the monitor must be supplied by internal power only.

1.2.5 Condensation

Make sure that during operation, the instrument is free of condensation. Condensation can form when equipment is moved from one building to another, thus being exposed to moisture and differences in temperature.

1.2.6 Safety Precautions

WARNING and **CAUTION** messages must be observed. To avoid the possibility of injury, observe the following precautions during the operation of the instrument.

WARNING

- 1 If liquid is inadvertently splashed on the equipment or its accessories, it may enter the conduit or inside the monitor. At this moment, contact local Customer Service Center.
 - 2 The monitor is intended to be used by qualified physicians or personnel professionally trained. And they should be familiar with the contents of this user manual before operation.
 - 3 Only qualified service engineers can install this equipment. And only service engineers authorized by EDAN can open the shell.
 - 4 **EXPLOSION HAZARD**-Do not use the monitor in a flammable atmosphere where concentrations of flammable anesthetics or other materials may occur.
 - 5 **SHOCK HAZARD**-To avoid the **RISK** of electric shock, this equipment must only be connected to a **SUPPLY MAINS** with protective earth.
 - 6 Do not attempt to connect or disconnect a power cord with wet hands. Make certain that your hands are clean and dry before touching a power cord.
 - 7 The recommended battery can only be used for this monitor. Do not connect battery directly to an electric outlet or cigarette lighter charger.
 - 8 Do not unplug the battery when monitoring.
 - 9 Always keep the battery away from fire.
 - 10 Clinical decision making based on the output of the device is left to the discretion of the provider.
-
-

WARNING

- 11 Do not solder the leading wire and the battery terminal directly.
 - 12 Make sure the monitor is used in the appointed range of voltage so that the effect of power supply can be ignored.
 - 13 Accessory equipment connected to the analog and digital interfaces must be certified according to the respective IEC/EN standards. Furthermore all configurations shall comply with the valid version of the system standard IEC/EN60601-1. Everybody who connects additional equipment to the signal input connector or signal output connector configures a medical system, and is therefore responsible that the system complies with the requirements of the valid version of the system standard IEC/EN60601-1. If in doubt, consult our technical service department or your local distributor.
 - 14 The simultaneous use of cardiac pacemaker and other patient-connected equipment may cause safety hazard.
 - 15 If liquid leaking from the battery gets into your eyes, onto your skin or clothes, do not rub your eyes. Wash them well with clean water and go to see a doctor immediately.
 - 16 Stop using the battery if abnormal heat, odor, discoloration, deformation or abnormal condition is detected during use, charge, or storage. Keep it away from the monitor.
 - 17 Do not use a battery with serious scratch or deformation.
 - 18 Only patient cable and other accessories supplied by EDAN can be used. The performance and electric shock protection cannot be guaranteed, and the patient may be injured otherwise. Prior to use, check if the casing of a disposable or sterilized accessory is intact. Do not use it if its casing is damaged.
 - 19 The user should check the monitor and accessories before use.
 - 20 Please set the alarm according to the individual status of patient to avoid delaying treatment. Ensure there will be alarm audio prompt when alarming.
 - 21 Devices connecting with monitor should be equipotential.
 - 22 The monitor is equipped with a wireless AP/Wi-Fi via network interface to receive RF electromagnetic energy. Therefore, any other equipment complies with CISPR radiation requirements may also interfere with the wireless communication and make it interrupted.
 - 23 Please disinfect timely to prevent cross infection between patients.
 - 24 When the monitor and electrosurgical device are used together, the user (physician or nurse) should guarantee the safety of patient.
 - 25 This monitor is not a device for treatment purposes.
 - 26 Do not touch the patient, bed or instrument during defibrillation.
 - 27 Do not service or maintain the monitor or any accessory which is in use with the patient.
 - 28 During monitoring, if the power supply is off and there is no battery for standby, the monitor will be off. All last settings used will be recovered when the power is restored.
-
-

WARNING

- 29 If leakage or foul odor is detected, ensure that there's no fire around.
 - 30 Only NIBP and SpO₂ applied parts of the monitor are defibrillation-proof. When a defibrillator is applied, keep other accessories away from the patient. Otherwise, it may result in damaging the monitor or harming the patient.
 - 31 The appliance coupler or mains plug is used as isolation means from supply mains. Position the monitor in a location where the operator can easily access the disconnection device.
 - 32 Wireless LAN equipment contains an intentional RF radiator that has the potential of interfering with other medical equipment, including patient implanted devices. Be sure to perform the electromagnetic compatibility test before installation and any time new medical equipment is added to the Wireless LAN coverage area.
 - 33 The equipment can provide protective means to prevent the patient from being burned when used with HF SURGICAL EQUIPMENT. Use only EDAN-approved accessories.
 - 34 Without any external memory, all data measured (including trend data, review data, alarm events and so on) are cleared either when the monitor is turned off or when the monitor is powered down in the process of monitoring.
 - 35 Only items that have been specified as part of the system or specified as being compatible with the system can be connected to the system.
 - 36 SHOCK HAZARD - Don't connect electrical equipment, which has been supplied as a part of the system, directly to the wall outlet when the non-medical equipment is intended to be supplied by a multiple portable socket-outlet with an isolation transformer.
 - 37 SHOCK HAZARD - Don't connect electrical equipment, which has not been supplied as a part of the system, to the multiple portable socket-outlet supplying the system.
 - 38 Do not touch accessible parts of medical or non-medical electrical equipment in the patient environment and the patient simultaneously, such as USB connector, VGA connector or other signal input/output connectors.
 - 39 Connecting any accessory (such as external printer) or other device (such as the computer) to this patient monitor makes a medical system. In that case, additional safety measures should be taken during installation of the system, and the system shall provide:
 - a) Within the patient environment, a level of safety comparable to that provided by medical electrical equipment complying with IEC/EN 60601-1, and
 - b) Outside the patient environment, the level of safety appropriate for non-medical electrical equipment complying with other IEC or ISO safety
 - 40 Additional multiple socket-outlet or extension cord can't be connected to the system.
 - 41 Setting alarm limits to extreme values may cause the alarm system to become ineffective. It is recommended to use the default settings.
-
-

WARNING

- 42 The medical electrical equipment needs to be installed and put into service according to the EMC Information provided in this user manual.
 - 43 Portable and mobile RF communications equipment can affect medical electrical equipment; refer to the recommended separation distances provided in Appendix A2 EMC Information.
 - 44 Operation of the equipment exceeding specified physiological signal or the operational specification may cause inaccurate results.
 - 45 The use of patient cable and other accessories not supplied by the manufacturer may result in increased emissions or decreased immunity of the equipment.
 - 46 The monitor should not be used adjacent to or stacked with other equipment. If adjacent or stacked use is necessary, you must check that normal operation is possible in the necessary configuration before you start monitoring patients.
 - 47 When the monitor is used with HF surgical equipment, the transducer and the cables must be avoided from conductive connection to the HF equipment. This is to protect against burns to the patient.
 - 48 To protect the monitor from damage during defibrillation, for accurate measurement information and to protect against noise and other interference, use only accessories specified by EDAN.
 - 49 No modification of this equipment is allowed without authorization of the manufacturer. If this equipment is modified, appropriate inspection and testing must be conducted to ensure continued safe operation.
 - 50 Only recommended batteries can be used for the monitor.
 - 51 If several items of medical equipment are interconnected, pay attention to the sum of the leakage currents, otherwise it may cause shock hazard. Consult your service personnel.
 - 52 The device must be connected to the ground to avoid signal interference.
 - 53 Portable RF communications equipment (including peripherals such as antenna cables and external antennas) should be used no closer than 30 cm (12 inches) to any part of the monitor, including cables specified by the manufacturer. Otherwise, degradation of the performance of this equipment could result.
 - 54 Route all cables carefully to avoid possible entanglement, apnea, or electrical interference. For the device mounted over the patient, sufficient precautionary measures should be taken to prevent it from falling on the patient.
 - 55 Make sure networking function is used in a secure network environment.
-
-

CAUTION

- 1 Federal law (U.S.) restricts this device to sale by or on the order of a physician.
 - 2 Electromagnetic Interference – Ensure the environment in which the monitor is installed is not subject to any sources of strong electromagnetic interference, such as radio transmitters, mobile telephones, microwaves, etc.
 - 3 The monitor is designed for continuous operation and is “ordinary” (i.e. not drip or splash-proof).
 - 4 Keep the environment clean. Avoid vibration. Keep it far from corrosive medicine, dust area, high-temperature and humid environment.
 - 5 The monitor is suitable for use in the presence of electrosurgery. When the monitor is used with HF surgical equipment, user (doctor or nurse) should be cautious about patient safety.
 - 6 Do not immerse transducers in liquid. When using solutions, use sterile wipes to avoid pouring fluids directly on the transducer.
 - 7 The device and reusable accessories may be sent back to the manufacturer for recycling or proper disposal after their useful lives. Alternatively, they can be returned to the dealer or the manufacturer for recycling or proper disposal.
 - 8 Avoid liquid splash and excessive temperature. The working temperature must be kept between 0 °C and +40 °C, and it is recommended to be kept between +10 °C and +40 °C when the monitor is equipped with TEMP module. The temperature should be kept between -20 °C and +55 °C during transportation and storage, and it is recommended to be kept between -20 °C and +50 °C when the monitor is equipped with TH module.
 - 9 If the monitor gets damp, put it in dry circumstance to dry it until it can work normally. If liquid pours on the monitor, please contact the service personnel authorized by EDAN.
 - 10 Remove a battery whose life cycle has expired from the monitor immediately.
 - 11 Before using the device, the equipment, patient cable and electrodes etc. should be checked. Replacement shall be taken if there is any evident defect or signs of aging which may impair the safety or performance.
 - 12 A potential hazard can exist if different alarm presets are used for the same or similar equipment in any single area.
 - 13 Assembly of the monitor and modifications during actual service life shall be evaluated based on the requirements of IEC60601-1.
 - 14 Disposable devices are intended for single use only. They should not be reused as performance could degrade or contamination could occur.
 - 15 A ventilated environment is required for monitor installation. Do not block up the ventilation grille at the back of the device.
 - 16 Poor connection might be caused by frequently plugging and unplugging the power cord. Check the power cord regularly and replace it in time.
-
-

NOTE:

- 1 Position the device in a location where the operator can easily see the screen and access the operating controls.
- 2 The monitor can only be used on one patient at a time.
- 3 This equipment is not intended for home usage.
- 4 If the device is discolored or damaged, then discontinue use of the device.
- 5 The pictures and interfaces in this manual are for reference only.
- 6 Regular preventive maintenance should be carried out every two years. You are responsible for any requirements specific to your country.
- 7 The materials with which the patient or any other person can come into contact conform to the standard of EN ISO 10993-1: 2013.
- 8 It is recommended to format the USB flash drive to the FAT file type via PC prior to use.
- 9 To protect eyes from damage, don't look directly at supplementary light for long time.
- 10 When there's measurement beyond range, invalid measurement or no measurement value, it will display ---.
- 11 In normal use, the operator shall stand in front of the monitor.

1.2.7 Protecting Personal Information

Protecting personal health information is a major component of security strategy. To protect the personal information and ensure the proper device performance, the user should take necessary precautions in accordance with local laws and regulations and institution's policies. EDAN recommends health care organizations or medical institutions to implement a comprehensive and multifaceted strategy to protect the information and systems from internal and external security threats.

To ensure the patients' safety and protect their personal health information, the user should implement security practices or measures that include:

1. Physical safeguards - physical safety measures to ensure that unauthorized personnel do not have access to the monitor.
2. Operational safeguards - safety measures during operation.
3. Administrative safeguards - safety measures in management.
4. Technical safeguards - safety measures in technical field.

CAUTION

- 1 The access/operation of the monitor is restricted to authorized personnel only. Assign only staff with a specific role the right to use the monitor.
 - 2 Ensure that all device components maintaining personal information (other than removable media) are physically secure.
-



CAUTION









- 3 Ensure that the data are deleted after the patient is discharged. (Refer to Section 4.12 *Data Store*).
- 4 Ensure that the monitor is connected only to the device authorized/approved by EDAN. Users should operate all EDAN deployed and supported monitors within EDAN authorized specifications, including EDAN approved software, software configuration, security configuration, etc.
- 5 Protect all the passwords to prevent unauthorized changes.
- 6 Anti-virus measures such as USB device virus scanning should be carried out prior to using USB flash drive.
- 7 Firewalls and/or other security devices should be in place between the medical system and any externally accessible systems. It's recommended to use Windows defender firewall or any other firewall that can defend against Dos and DDos attacks, and keep it up to date.
- 8 When the monitor is returned for maintenance, disposed of, or removed from the medical institution for other reasons, it is necessary to ensure that all patient data are removed from the monitor. (Refer to Section 4.12 *Data Store*).
- 9 Please protect the privacy for the information and the data displayed on the screen, and for the information and the data stored in the monitor.
- 10 When building the networking environment: 1) If a wireless router is used, please turn on the MAC address filtering function of the wireless router and add the MAC address of the monitor to the rule list. The wireless router only allows devices in the rule list to access the wireless network. 2) It is suggested to build a VLAN, assign the LAN ports where the approved switch port, monitor and MFM-CMS are into the same VLAN, and isolate it from other VLANs.









NOTE:

Log files generated by the monitor are used for system troubleshooting and do not contain protected medical data.

1.2.8 Explanation of Symbols on the Monitor

1		TYPE CF APPLIED PART
2		DEFIBRILLATION-PROOF TYPE BF APPLIED PART
3		TYPE BF APPLIED PART

4		Caution
5		Operating instructions
6	P/N	Part Number
7		Refer to User Manual (Background: blue; Symbol: white)
8		Equipotential grounding
9		Power Supply switch
10	SN	SERIAL NUMBER
11	CE ₀₁₂₃	CE marking
12	EC REP	AUTHORISED REPRESENTATIVE IN THE EUROPEAN COMMUNITY
13		Date of manufacture
14		MANUFACTURER
15		General symbol for recovery/recyclable
16		Disposal method
17	Rx Only	Caution: Federal (US) law restricts this device to sale by or on the order of a physician.
18	IPX1	Ingress Protection IPX1 (Protected against vertically falling water drops)

19		Warning (Background: yellow; Symbol and outline: black)
20		This Way Up
21		Fragile
22		Keep Away From Rain
23		Stacking Limit By Number
24		Handle with care
25		Do not step on
26	<p>ETL CLASSIFIED</p>  <p>Intertek 4005997</p>	<p>Conforms to UL Std. 60601-1, IEC Std. 60601-2-30, IEC Std. 60601-2-49</p> <p>Certified to CSA Std. C22.2 No 601.1, CSA Std. C22.2 No 60601-2-30, CSA Std. C22.2 No 60601-2-49</p>

NOTE:

The user manual is printed in black and white.

Chapter 2 Installation of Monitor

NOTE:

To ensure that the monitor works properly, please read *Chapter 1 Intended Use and Safety Guidance*, and follow the steps before using the monitor.

2.1 Opening the Package and Checking

Visually examine the package prior to unpacking. If any signs of mishandling or damage are detected, contact the carrier to claim for damage. Open the package and take out the monitor and accessories carefully. Keep the package for possible future transportation or storage. Check the components according to the packing list.

- ◆ Check for any mechanical damage.
- ◆ Check all the cables, modules and accessories.

If there is any problem, contact the manufacturer or local representative immediately.

2.2 Connecting the Power Cable

Connection procedure of the AC power line:

- ◆ Make sure the AC power supply complies with following specification: 100 V–240 V ~, 50 Hz/60 Hz.
- ◆ Connect the power cord provided with the monitor. Connect the power cord to connector of the monitor. Connect the other end of the power cord to a grounded power outlet.

NOTE:

Connect the power line to the jack special for hospital usage.

- ◆ Connect to the ground line if necessary. Refer to *section 1.2 Safety Guidance* for details.

NOTE:

When the battery configuration is provided, after the monitor is transported or stored, the battery must be recharged. Switch on AC power supply can recharge the battery no matter if the monitor is powered on.

2.3 Powering on the Monitor

Press the **ON/OFF** button on front panel to power on the monitor, LOGO information will be displayed on the screen.

WARNING

Do not use it on any patient if any sign of damage is detected, or the monitor displays some error messages. Contact biomedical engineer in the hospital or Customer Service Center immediately.

NOTE:

- 1 Check all the functions of the monitor and make sure that the monitor is in good condition.
- 2 If rechargeable batteries are provided, recharge them after using the monitor every time to ensure the electric power is enough.
- 3 After long-time continuous running, please restart the monitor to ensure the monitor's steady performance and long lifespan.
- 4 If the system is not used for a longer period of time, its system time may be inaccurate. In this case, reset the system time after powering on.
- 5 If the system time cannot be saved and resumes the default value after restart, contact the service department of EDAN to replace the button cell in main board.

2.4 Connecting Sensor to Patient

Connect all the necessary patient sensors between the monitor and the patient.

NOTE:

For information on correct connection, refer to related chapters.

2.5 Checking the Recorder

If your monitor is equipped with a recorder, open the recorder door to check if paper is properly installed in the slot. If no paper is present, refer to *Chapter 6 Trend and Recording* for details.

Chapter 3 Introduction

3.1 General Information

The monitor integrates the function of parameter measurement modules, display, recording and output to compose a compact, portable device. Its built-in replaceable battery provides convenience for patient movement. On the LCD display screen, SpO₂ waveform and all the monitoring parameters can be displayed clearly.

You may frequently use the following functions:

- ◆ SpO₂ monitoring (Refer to Chapter *Monitoring SpO₂* for details)
- ◆ TEMP monitoring (Refer to Chapter *Monitoring TEMP* for details)
- ◆ NIBP monitoring (Refer to Chapter *Monitoring NIBP* for details)
- ◆ Alarm (Refer to Chapter *Alarms* for details)

The monitor is a user-friendly device with operations conducted by a few buttons on the front panel. Refer to *section 3.3 Button Functions* for more details.



Figure 3-1 M3 Vital Signs Monitor

M3 Vital Signs Monitor can monitor:

- SpO₂: Arterial Oxygen Saturation (SpO₂);
- Pulse Rate (PR);
- SpO₂ PLETH (Plethysmogram);

NIBP: Systolic Pressure (SYS);
 Diastolic Pressure (DIA);
 Mean Pressure (MAP);
 Pulse Rate (PR).

TEMP: Temperature (TEMP)

3.2 Screen Display

The monitor is equipped with LCD. The patient parameters, waveforms, alarm messages, patient ID, time, monitor status and other information can be reflected from the screen.

If the monitor is outfitted with the modules SpO₂, NIBP and TEMP, the three parameters SpO₂, NIBP and TEMP are onscreen in the general display mode. If the monitor is configured to the double-parameter measuring function as NIBP+SpO₂ or NIBP+TEMP, double parameters will be displayed onscreen. Also, the monitor can be configured to single parameter mode with SpO₂ measuring only or NIBP measuring only. In SpO₂ only or NIBP only measuring mode, the single parameter of SpO₂ or NIBP is displayed.

The configuration is preset by the manufacturer; it cannot be changed by the user.

3.2.1 General Display Mode

The screen is divided into three areas:

- 1 Parameter area ①
- 2 Waveform/Trend list/Alarm list area ②
- 3 Information area ③ ④

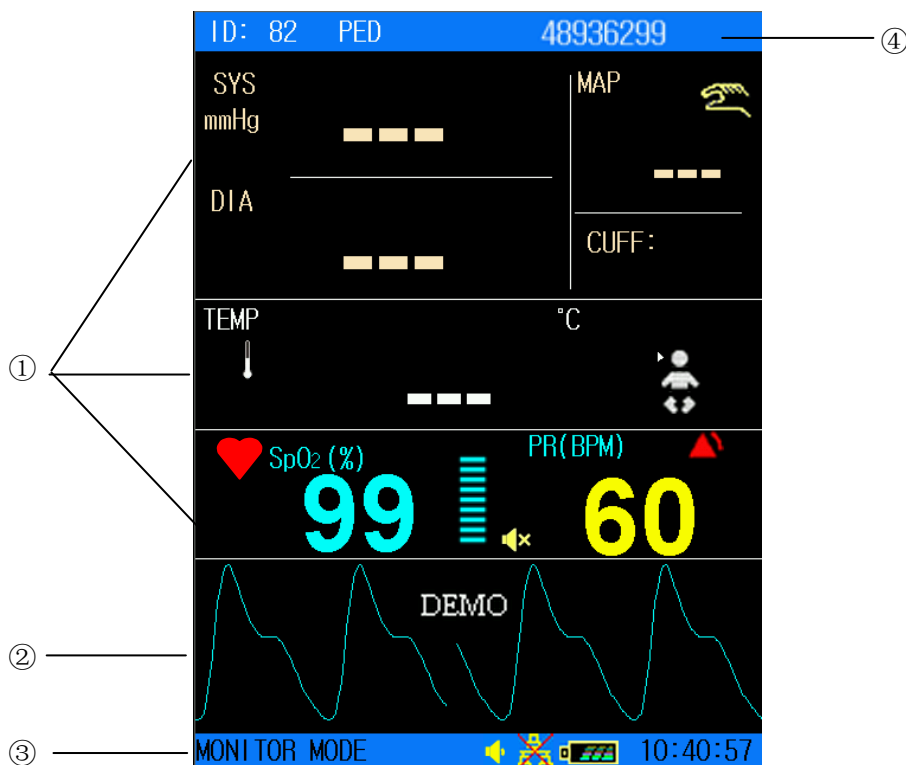

Figure 3-2 Main Display with Waveform

The Waveform area can display parameter trend list or alarm list. It displays as follows:

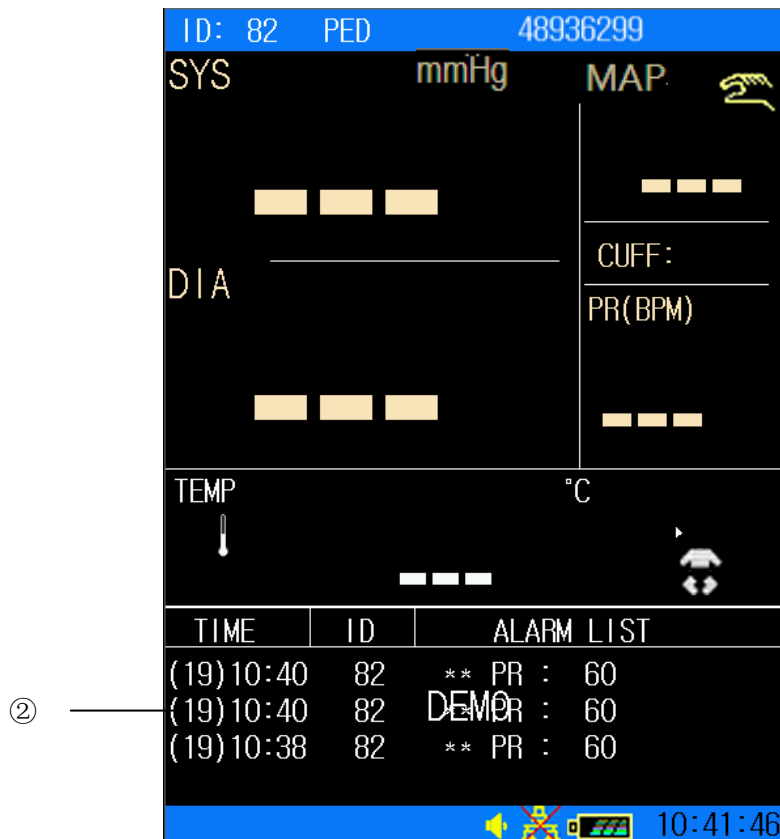

Figure 3-3 Main Display with Alarm List

The display on the screen can be changed to a trend graph as follows:

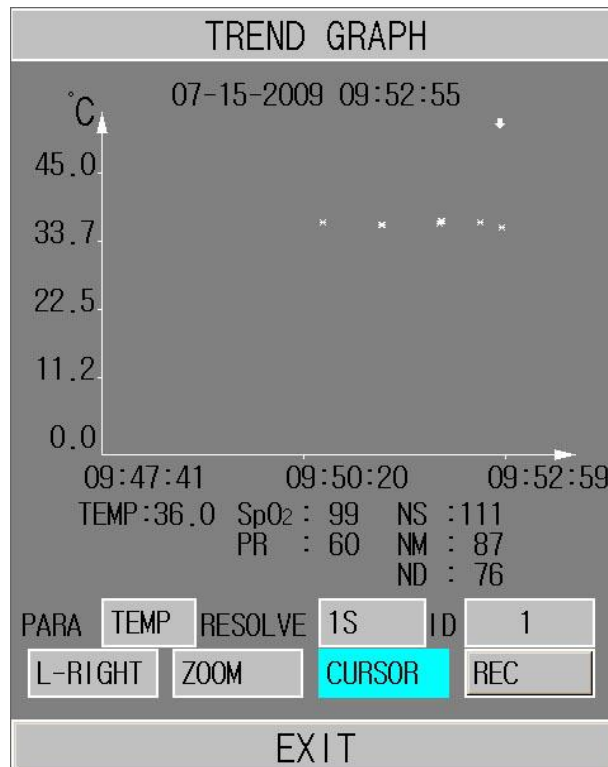



























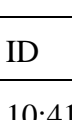

Figure 3-4 Display Trend Graph

The icons on the interface and their meanings are as follows:

	Battery status indicator
	Connected to mains power supply
	Barcode
	Volume indicator
	Network connection indicator
	Network connection off
	Medium/Low alarm
	High alarm icon
	Audio alarm off
	Audio alarm paused
	Parameter alarm off
	Patient type: ADU
	Patient type: PED
	Patient type: NEO
	NIBP manual mode
	NIBP interval mode
	NIBP continual mode
	Heart beat

	Measuring oral TEMP in ADU mode	For device with the T2 or F3000 TEMP module only.
	Measuring axillary TEMP in ADU mode	
	Measuring rectal TEMP in ADU mode	
	Measuring oral TEMP in PED mode	
	Measuring axillary TEMP in PED mode	
	Measuring rectal TEMP in PED mode	
	Measuring TEMP	
	Measuring value of TEMP is above the upper alarm limit. (Only for Predictive Mode)	
	Measuring value of TEMP is below the lower alarm limit. (Only for Predictive Mode)	
	Measuring ear TEMP	For device with the Infrared Ear Temperature module only.
ID	Current patient ID	
10:41:46	Current time	

Parameter Area (①)

Parameter area is on the right of Waveform area, and parameters are displayed:

SpO₂:

- SpO₂ (Unit: %)
- PR (Pulse Rate, Unit: BPM).
- SpO₂ alarm limit

NIBP:

- SYS, DIA, MAP (Unit: mmHg or kPa, 1 mmHg=0.133 kPa)
- Pulse Rate (Pulse Rate, Unit: bpm)
- NIBP measuring mode

TEMP: Temperature (Unit: °C or °F).

The PR signal from SpO₂ measuring takes priority to be displayed.

Waveform/Trend List/Alarm List Area (②)

It can display SpO₂ waveform, Trend tab or Alarm list. You can select it in the **SELECTION of SYSTEM MENU**.

Information Area (③ ④)

The information areas are to display operating status of the monitor and condition of the patient, including the following data:

- Patient type and ID;
- Signs indicating the net connection status;
- Signs indicating the battery or mains power supply status;
- Current time;
- Signs indicating the volume status;
- Alarms and prompts.

Alarm Indicator and Alarm Status

- In normal condition, the alarm indicator does not light.
- When an alarm is generated, the alarm indicator lights or flashes. The color of light represents the alarm level. Refer to *Chapter 5 Alarm* for details.
- Refer to relevant content of parameters for Alarm information and prompt.

Charging Indicator and Charging Status

To indicate the status of charging: when the battery is being charged, the light turns to yellow; after the charge is finished, the light will be off.

3.2.2 Double-Parameter Mode

NIBP+SpO₂ Interface

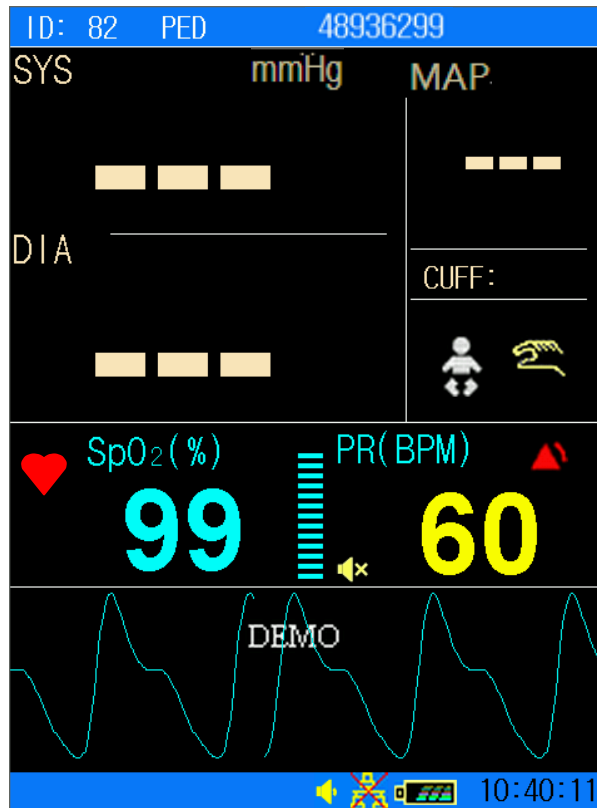

Figure 3-5 NIBP as the Main Parameter

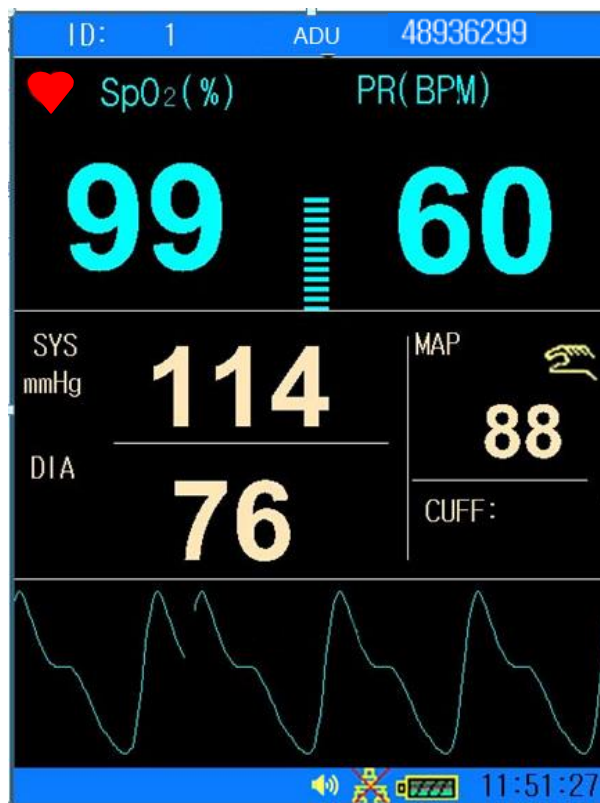

Figure 3-6 SpO₂ as the Main Parameter

NIBP+TEMP Interface

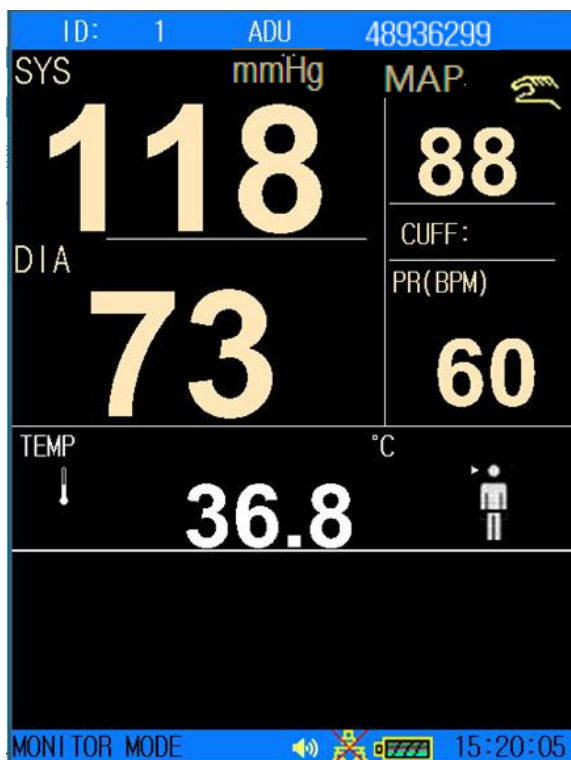

Figure 3-7 NIBP+TEMP Interface

3.2.3 Single Parameter Mode

SpO₂ only measuring mode

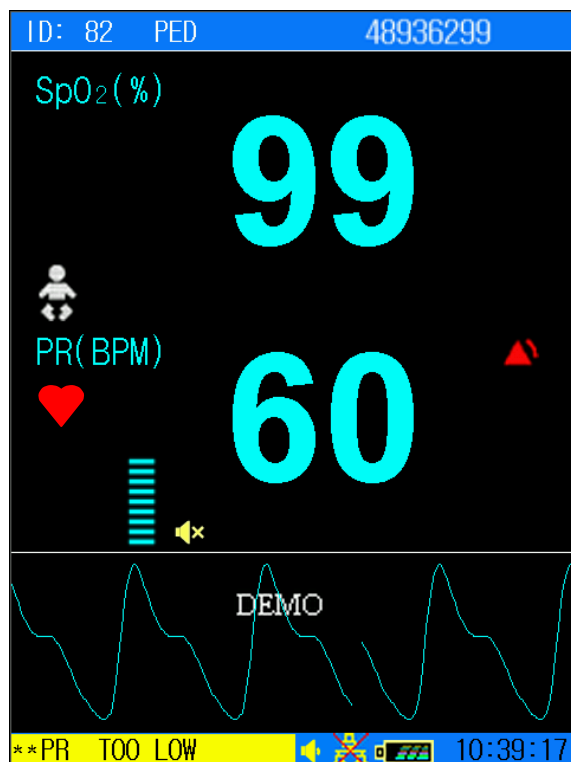

Figure 3-8 Display in SpO₂ only Mode

NIBP only measuring mode

In NIBP only measuring mode, the PR from NIBP measurement is also displayed on screen.

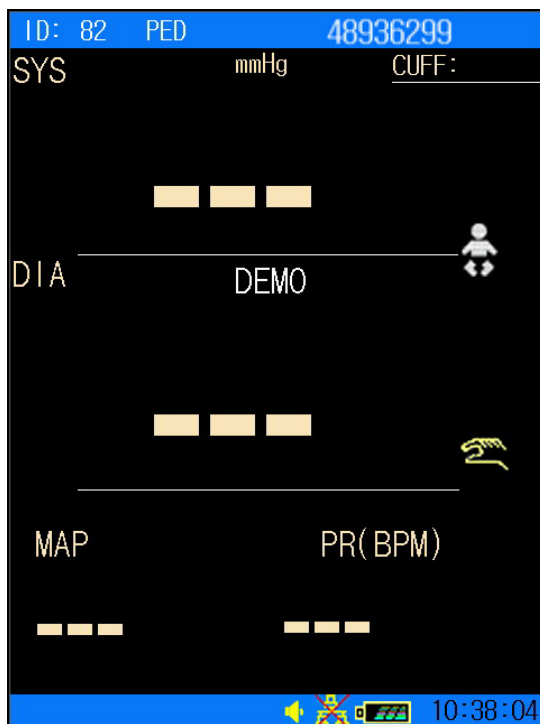

Figure 3-9 Display in NIBP only Mode

3.3 Button Functions

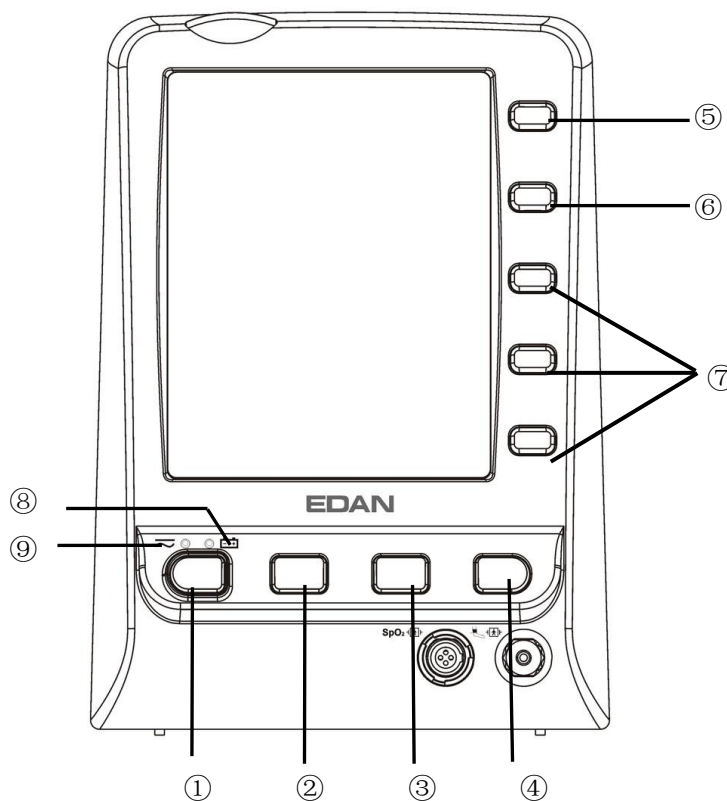













Figure 3-10 Buttons

All the operations to the monitor can be finished by several buttons.

①	<p>ON/OFF</p> 	<p>When the monitor is off, press this button to switch on the monitor. When the monitor is on, press this button for less than 1 s, the monitor will enter the sleep mode (if STANDBY is set to ON). Press this button and hold it for ≥ 2 s to switch off the monitor.</p>
②	<p>AUDIO ALARM PAUSED/OFF</p> 	<p>Press this button to pause or turn off the auditory alarm as needed.</p>
③	<p>NIBP START/STOP</p> 	<p>To inflate the cuff and start blood measuring. During the measuring process, press the button to stop measuring. (For the monitor with NIBP function).</p>
	<p>ALARM LIMIT</p> 	<p>For SpO₂ only monitor, the NIBP STASRT/STOP button is changed to ALARM LIMIT button. Press this button to set the alarm limit of the parameters of SpO₂.</p>
④	<p>TREND/WAVEFORM</p> 	<p>Press this button to switch between waveform display, trend graph and trend list display.</p>
⑤	<p>HOT KEY (RECORD/SHORTCUT KEY FOR CHANGING PATIENT TYPE)</p> 	<p>In the monitoring mode, this hot key is configured as the record button by default. Press it, and you can print out the currently displayed waveforms, trend graph, trend lists or alarm lists. Pressing it while recording can stop recording.</p> <p>In the spot check mode, this hot key is configured as the shortcut key for changing the patient type. You can rapidly alter the patient type by pressing this button.</p>
⑥	<p>MENU</p> 	<p>Press to open the SYSTEM MENU. Refer to <i>Chapter 4 System Menu</i> for details.</p>
⑦	 UP  OK  DOWN	<p>Select the items in menu, or decrease or increase the items. Confirm the selection by pressing OK.</p>

The icons on the front panel:

⑧	 CHARGE Indicator	The LED besides this icon indicates the charging status. When the battery is being recharged, the LED is bright.
⑨	 POWER Indicator	The LED besides this icon indicates the power status. When the monitor connects to the mains power supply, the LED is bright.

3.4 Interfaces

For the convenience of operator, interfaces of different functions are in different sites of the monitor. There is a USB port on rear panel for Data storing function.

Left side of the monitor

At the left side of the monitor is the recorder (①).



Figure 3-11 Left Panel

Sensor port on the front panel

Connectors for cables and sensors are as shown in Figure 3-11.

1. SpO₂ sensor connector ②
2. NIBP cuff connector ③

Right side of the monitor

If the monitor has TEMP function, there will be TEMP module and thermometer outfitted on the right side. Three optional TEMP measurement modules are available: T2 module, TH module (Infrared Ear Temperature module) and F3000 module. Refer to Figure 3-12.

With T2 TEMP Module:

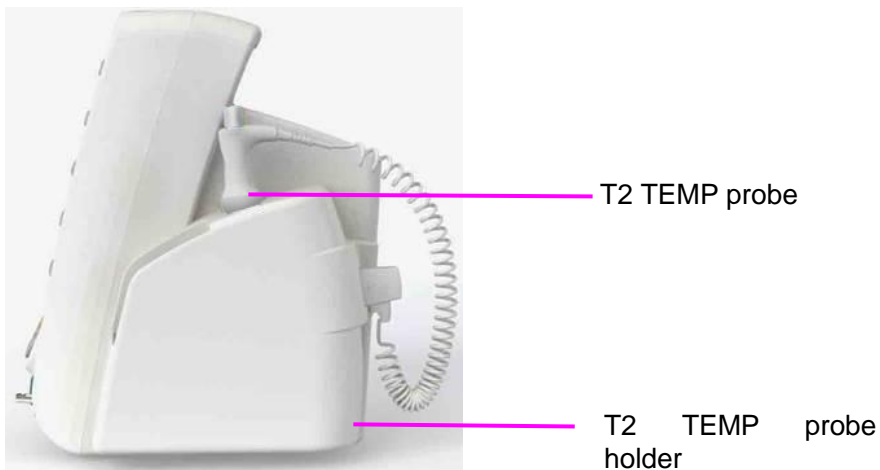

With Infrared Ear Temperature Module:

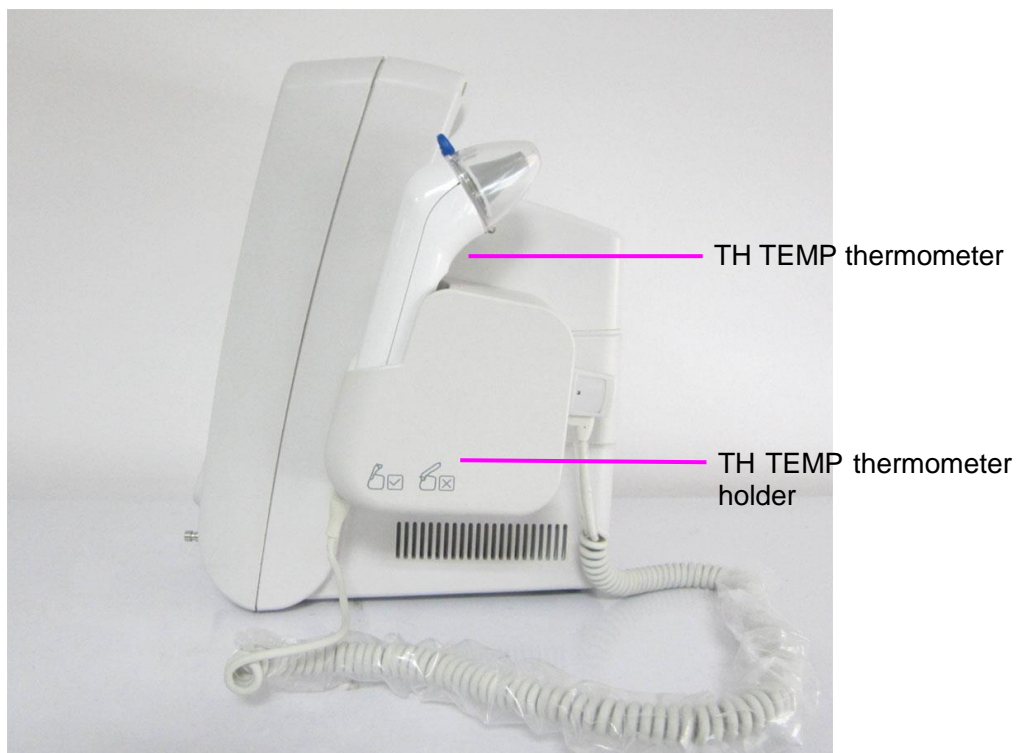

With F3000 TEMP Module:



Figure 3-12 Right Panel

WARNING

Only connect accessories supplied or recommended by EDAN to the device.

Rear Panel

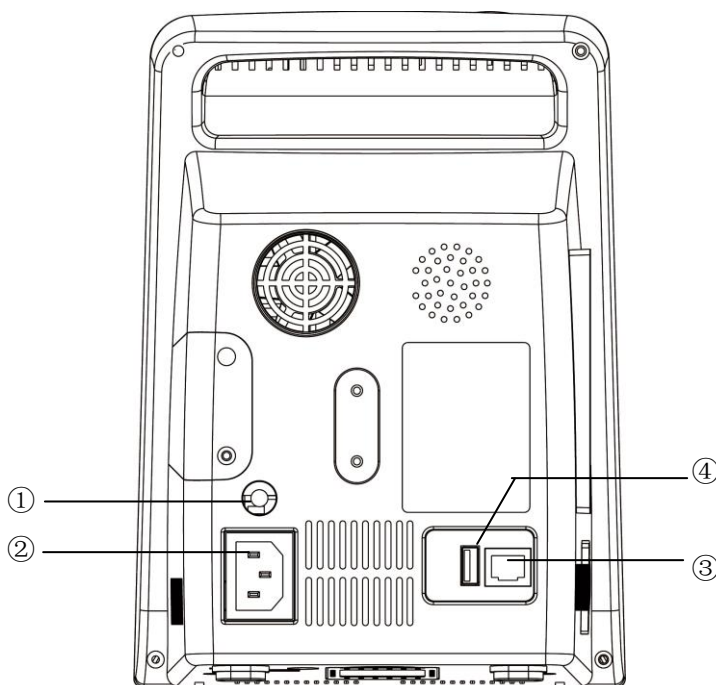

Figure 3-13 Rear Panel of M3

Sockets on the rear panel are shown in the above figure:

- ① Equipotential grounding terminal for connection with the hospital's grounding system.

- ② Power supply socket: 100 V–240 V ~, 50 Hz/60 Hz.
- ③ Network Interface: Standard RJ45 Socket, for connecting to MFM-CMS of EDAN.
- ④ USB connecting port for USB storage.

Bottom panel

There are battery compartment and fuse box on the bottom panel.

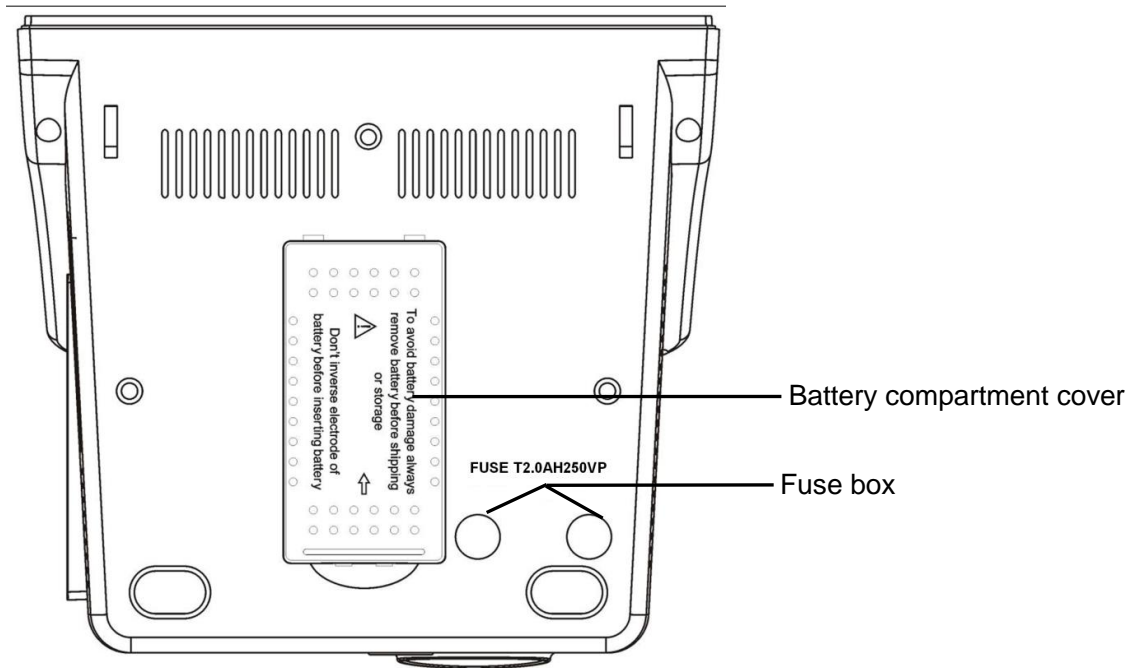

Figure 3-14 Bottom Panel

3.5 Built-in Rechargeable Battery

3.5.1 Battery Safety Information



WARNING



- 1 Do not take off the battery when monitoring. The unexpected power supply off cannot impact the monitor normal working, if it has battery for standby.
- 2 Stop using the battery if abnormal heat, odor, discoloration, deformation or abnormal condition is detected during use, recharge, or storage. Keep it away from the monitor.
- 3 Make sure the monitor is used in the appointed range of voltage so that the effect of power supply can be no noticeable.
- 4 Before using the rechargeable lithium-ion battery (hereinafter called battery), be sure to read the user manual and safety precautions thoroughly.
- 5 Do not place battery in the monitor with the (+) and (-) in the wrong way around.
- 6 Do not connect the positive (+) and negative (-) terminals with metal objects, and do not put the battery together with metal objects, which can result in short circuit.
- 7 Do not heat or throw battery into fire.

WARNING

- 8 Do not use, leave battery close to fire or other places where temperature may be above +60 °C. Do not immerse, throw, and wet battery in water/seawater.
- 9 Do not destroy the battery, do not pierce battery with a sharp object such as a needle; do not hit with a hammer, step on or throw to cause strong shock; do not disassemble or modify the battery.
- 10 Take out the battery before cleaning or storing the monitor for more than 1 month.
- 11 The service life of the battery depends on the service frequency and time. The service life of the battery is about three years if the battery is well maintained and stored. The service life of the battery may shorten if it is used inappropriately. If the battery life is exhausted and not replaced in time, it may cause damage or heat to the device.





3.5.2 Battery Status on the Main Screen

The monitor is equipped with a built-in rechargeable battery. When switching on AC power supply, the battery will be recharged automatically until full electric energy. There is a sign  or  in the bottom right corner of screen.

- When the monitor is working with AC mains power, and it has no battery or the battery has full electric energy, it displays ;
- When the monitor is working with AC mains power, and the battery is being recharged, it displays ;
- When the monitor is working with battery, it displays .

If the monitor is off, you can see recharging status from the charger indicator. Battery status light is yellow when recharging, off when full.

Battery status symbols show the status of battery and the battery power remaining;

-  Remaining battery power: 100%.
-  Remaining battery power: 75%
-  Remaining battery power: 50%
-  Remaining battery power: 25%
-  Batteries are almost depleted and need to recharge immediately.

3.5.3 Checking Battery Performance

The performance of rechargeable batteries may deteriorate over time. Battery maintenance as recommended here can help to slow down this process.

1. Disconnect the patient from the monitor and stop all monitoring and measurement.
2. Switch the monitor power on and charge the battery for more than 6 hours continuously.

3. Disconnect monitor from mains power and let the monitor run until there is no battery power left and the monitor shuts off.
4. The running time of the battery reflects the battery performance.

If the running time is obviously less than the specified time in the specification, please change the battery or contact the service personnel.

3.5.4 Replacing the Battery

During monitoring state or communication state, when the battery is low or empty, the monitor will indicate a “BATTERY LOW” alarm.

When the lifespan of battery is over, or foul odor and leakage has been detected, please contact the manufacturer or local distributor for replacement of battery.

3.5.5 Recycling the Battery

When the battery no longer holds a charge, it should be replaced. Remove the old battery from the monitor and recycle it properly.

3.5.6 Maintaining the Battery

Batteries should be conditioned regularly to maintain their useful life.

Remove the batteries from the monitor if they are not used for a longer period of time. And recharge the batteries at a minimum of every 6 months when they are stored.

Discharge the battery completely once every month.

3.5.7 Battery Alarm Information

Technical Alarm:

Message	Cause	Alarm Level	What to do
Battery Low	Battery Low	High	Change the battery or charge the battery.

Chapter 4 System Menu

The monitor features in flexible configurations. You can configure various aspects of the monitor, including the parameters to be monitored, audio signal volume, and output content.

Press **MENU** on the front panel to open **SYSTEM MENU**. You can perform the following operations in this menu.

4.1 Patient Setup

Click on **PATIENT SETUP** in **SYSTEM MENU** to open the menu.

You can set the following patient information:

- ◆ **PAT ID**: Patient ID, 1~1000;
- ◆ **PAT TYPE**: Patient type; **ADU**, **PED**, or **NEO**.

Press the **UP/DOWN** button on the front panel to select the items; then press the **OK** button to confirm.

- ◆ **BARCODE**: Display the patient barcode, maximum 20 bits.

Pick **EXIT** to return to the previous menu.

4.2 Default Setup

NOTE:

Select any item in this submenu to cancel the current setup and use the selected default setup.

- ◆ **FAC DEF CONFIG**: factory default configuration.
- ◆ **USER DEF CONFIG**: user-defined default configuration; The one labeled with ■ is current configuration.
- ◆ **CONFIRM**: Confirm your choice, exit this submenu, and return to the previous menu.

4.3 System Setup

In this submenu, **SYSTEM SETUP** has a few items to set:

- ◆ **ALARM VOL**: Set alarm volume to **HIGH**, **MED** or **LOW**.
- ◆ **STANDBY**: Set it to **ON** or **OFF** to enable or disable the Sleep Mode function (Refer to *4.12 Sleep Mode*).
- ◆ **KEY VOL**: Set key volume to **HIGH**, **MED**, **LOW** or **OFF**.
- ◆ **BRIGHTNESS**: Set screen brightness to **HIGH**, **MED** or **LOW**.
- ◆ **SPHY VOL**: Set sphygmoc volume to **HIGH**, **MED**, **LOW** or **OFF**.
- ◆ **WORK MODE**: Set work mode to **MONI** (monitoring mode) or **SPOT** (spot check mode).

NOTE:

- 1 The work mode will be indicated in the information area.
- 2 In the spot check mode, audio and visual prompts for all medium and low technical

alarms will be disabled; medium and low technical alarms will only be indicated by turns in the information area. In the monitoring mode, audio and visual prompts for all alarms will be effective and alarms will be indicated by turns in the information area.

- 3 In the spot check mode, medium and low technical alarms cannot disable the settings of silencing the alarm. Only when a new physiological alarm or a high technical alarm occurs can the monitor automatically exit the alarm silenced status. In the monitoring mode, if a new alarm of any type occurs, the monitor will automatically exit the alarm silenced status.
- 4 In the spot check mode, no trend graph will be shown.

- ◆ **WAVE FORM:** Set displayed waveforms to **UNFILLED** or **FILLED**.
- ◆ **FACE SELECT:** Set **NIBP** or **SpO₂** as the main displayed parameter onscreen (**FACE SELECT** is only available for the monitor with the configured modules NIBP+SpO₂).
- ◆ **RECORDER SPEED:** Set recorder speed to **12.5 mm/s** or **25 mm/s**.
- ◆ **EXIT:** Return to the previous menu.

4.4 Selection

For the monitor outfitted with SpO₂, NIBP and TEMP modules, you may select **SELECTION** in **SYSTEM MENU** to access this submenu, in which seven selections are available: **NIBP TREND TAB**, **SpO₂ TREND TAB**, **TEMP TREND TAB**, **ALL PARAMETERS**, **ALARM LIST**, **TREND GRAPH** and **TREND TABLE**. Only one item can be selected to display information on the interface.

- ◆ **NIBP TREND TAB:** to display NIBP trend table;
- ◆ **SpO₂ TREND TAB:** to display SpO₂ trend table;
- ◆ **TEMP TREND TAB:** to display TEMP trend table;
- ◆ **ALL PARAMETERS:** to display all parameters in the area;
- ◆ **ALARM LIST:** to display alarm list;
- ◆ **TREND GRAPH:** to display the trend graph;
- ◆ **TREND TABLE:** to display the trend table.

You can shift the data list to waveform display by pressing the **TREND/WAVEFORM** button on front panel.

For Single display mode, the **Selection** menus are different.

4.5 Deleting Data

If you press the button  when a trend list or an alarm list is displayed on the screen, it will display below selections:

DELETE ID: Entirely delete the trend and alarm data of the current monitored patient.

DELETE ALL DATA: Entirely delete the trend and alarm data of all the monitored patients.

Select **YES** to make the operation effective; select **NO** to cancel the operation.

4.6 Version

Select **VERSION** in **SYSTEM MENU** to check the version of the monitor and the configuration of the modules.

4.7 Time Setup

Select **TIME SETUP** in **SYSTEM MENU** to access the submenu of **TIME SETUP**. System time is in format of **Y-M-D**, **M-D-Y** or **D-M-Y**. Users can set the year, month, day, hour, minute and second. Pick the item you want to modify and confirm it by pressing **OK**. Select **EXIT** item to save the setup and return to the previous menu. If you want to exit the menu without saving it, press the **MENU** on front panel.

4.8 NIBP Setup

Refer to *9.4 NIBP Setup*.

4.9 TEMP Setup

Refer to *10.1.3 TEMP Setup for T2 Module* and *10.3.7 TEMP Setup for F3000 Module*.

4.10 Alarm Setup

Refer to *5.1.3 Alarm Setup*.

4.11 Maintain

Select **MAINTAIN** item in **SYSTEM MENU** to open **ENTER MAINTAIN PASSWORD** dialog box, in which you can enter password and then customize maintenance settings. Factory maintenance function is only available for the service engineers of EDAN or representative authorized by EDAN.

User Maintain

Input the user password **9 9 8 1** in the **USER KEY** box and press **OK**, **USER MAINTAIN** menu will pop up, in which you can set following items.

BED No.: Set the bedside number to a value from 1 to 64.

LANGUAGE: Set the displayed language.

NOTE:

You should restart the monitor after changing the displayed language to make the operation effective.

NURSE CALL: Turn on or off the nurse call. When the parameter alarm occurs, the monitor gives 3s nurse call alarm prompt; if the audible alarm or the audio system is off, the monitor can also give the nurse call alarm in abnormal condition.

The relay contact between pin7 and pin8 of RJ45 is normally open. But it is closed when an alarm is audible.

SERVER IP: It can be changed by the user according to the IP of PC installed with MFM-CMS

of EDAN.

SERVER PORT: Set server port.

PRES UNIT: Set the pressure unit to **mmHg** or **kPa**.

TEMP UNIT: Set the temperature unit to **°C** or **°F**.

HOT KEY: Set the hot key to **PATIENT** or **PRINT**.

COLOR SELECT: Set the color of displayed waveforms. 16 kinds of colors can be selected. Click on **DEFAULT** to return to the default configuration.

OTHER SETUP

● SpO₂ SETUP:

◆ SpO₂ ALARM LEV

You can configure the alarm level for **SpO₂ SENSOR OFF** to **HIGH** or **LOW**.

◆ SENSITIVITY

The SpO₂ reading is the average of data collected within a specific time. You can set **Sensitivity** to **HIGH**, **MED** or **LOW** via the menu. The higher the sensitivity is, the quicker the monitor responds to the changes in the patient's oxygen saturation level. Contrarily, the lower the sensitivity is, the slower the monitor responds to the changes in the patient's oxygen saturation level, but the measurement accuracy will be improved. When a critical patient is monitored, selecting high sensitivity will help to understand the patient's state.

◆ PI

PI is a numeric value indicating perfusion level. It reflects the perfusion level at the monitoring site. You can set it **ON** or **OFF**.

● NIBP SETUP:

◆ **AVG INTERVAL:** Set the average NIBP measurement interval to **1MIN**, **2MIN**, **3MIN**, **4MIN** or **5MIN**.

◆ **AVG TIMES:** Set the average NIBP measurement times to **3** or **5**.

◆ **RESET:** Select it to reset the NIBP module.

– Restore measurement status.

– Pick this item to restore initial settings of the pressure pump.

– When the pressure pump does not work properly and the system fails to give message for the problem, pick this item to activate self-test procedure, thus restore the system from abnormal performance.

◆ LEAK TEST

This item is used for an air leakage test. Select this item to start the air leakage test. Then the item will change into **STOP LEAK TEST**. Select it again, and the system will stop the air leakage test.

WARNING

This pneumatic test other than being specified in the ISO 81060-1 standard is to be used by the user to simply determine whether there are air leaks in the NIBP airway. If at the end of the test the system gives the prompt that the NIBP airway has air leaks, please contact the manufacturer for repair.

Procedure of the Air Leakage Test:

- 1) Connect the cuff securely with the socket for NIBP air hole.
- 2) Wrap the cuff around the cylinder of an appropriate size.
- 3) Access the **NIBP SETUP** menu.
- 4) Select **LEAK TEST** by pressing **UP/DOWN**. It indicates **Leak testing...** in the information area.
- 5) The system will automatically inflate the pneumatic system to about 180 mmHg. After 20 seconds to 40 seconds, if system leakage has detected, the system will automatically open the deflating valve to stop the leak test and indicates NIBP Leak. If no system leakage is detected when the pneumatic system is inflated to 180 mmHg, the system will perform a deflation to an approximate value of 40 mmHg and subsequently perform the second phase leak test. After 20 seconds to 40 seconds, the system will automatically open the deflating valve and provide corresponding indication based on the test result.
- 6) If the alarm information of **AIR LEAK** appears, it indicates that the airway may have air leaks. In this case, the user should check for loose connection. After confirming secure connections, the user should re-perform the pneumatic test. If the failure prompt still appears, please contact the manufacturer for repair.

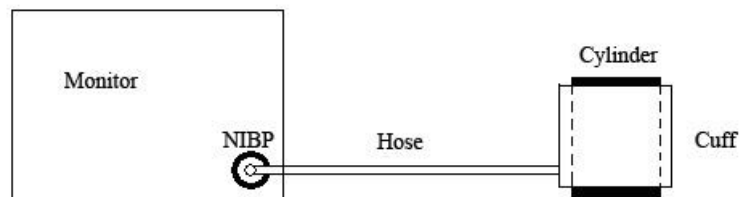

Figure 4-2 Diagram of NIBP Air Leakage Test



◆ **NIBP MEMORY**

You can set this item to **ON** or **OFF**. If the item is **ON**, the monitor will automatically memorize the initial measurements of the patient when measuring his or her blood pressure. Then the monitor will inflate the cuff according to the previous memorized measurements. This function accelerates the measuring of the patient's blood pressure.



● **ALARM SETUP**

◆ **AUDIO ALARM PAUSED**

To activate the auditory alarm function, you can set **AUDIO ALARM PAUSED** to any value:

60s, 120s or 180s, then press the button  on the front panel to pause audio alarm. The information area displays the remaining pause time in seconds with a yellow background. Key sounds and beat sounds keep their previous status. Auditory alarm will resume when you press the button  again or the pause time terminates.

◆ **AUDIO ALARM OFF**

To activate the Audio Alarm Off function, you can set **AUDIO ALARM OFF** to **ON**, then press the button  on the front panel and hold it for more than three seconds to turn off auditory alarm. Key sounds and beat sounds keep their previous status. Press the button  again to resume auditory alarm. If you set **AUDIO ALARM OFF** to **OFF**, the function is inactivated.

● **BARCODE SETUP**

◆ **ID:**

Patient ID can maximally be a three-digit number. On this precondition, you can determine which digit in the barcode is the starting/ending digit for the patient ID via configuration of **START** and **END**. Take the following barcode for example. If you set **START** to **2** and **END** to **4**, the updated patient ID will begin with the second digit and end with the fourth digit in the barcode, namely 787.



◆ **PAT TYPE:**

You can determine which digit in the barcode indicates the patient type. For example, if you set **PAT TYPE** to **1**, the first digit in the barcode will be identified as an indication of patient type.

◆ **ON/OFF:**

If it is set to **ON**, the patient information is updated automatically by using a barcode scanner. If it is set to **OFF**, a message box indicating “**Confirm to update patient, yes?**” will pop up when scanning a barcode. Click on **YES** to automatically update patient information; click on **NO** to quit automatically update.

◆ **ADU, PED, NEO:**

Select a digit from 0~9 to indicate the patient type. For example, if **ADU** is set to **9**, **PAT TYPE** is set to **1**, and the first digit in the barcode is 9, the patient type could be updated to ADU.

NOTE:

- 1 The set value of **START/END** in **ID** as well as the set value of **PAT TYPE** must not exceed the length of the barcode.

- 2 If **START/END** is set to **0**, the patient ID will not be updated by using barcode scanner.
- 3 If **PAT TYPE** is set to **0**, the patient type will not be updated by using barcode scanner.
- 4 Barcodes containing characters other than digits or containing space will be considered invalid and cannot be identified. If any invalid character is detected, a message box indicating “**Special signs are in code bar!**” will pop up.
- 5 Connect the barcode scanner to the monitor and wait 10 seconds before starting the scanner.
- 6 Refer to the accompanying operator’s manual of the scanner for more information about its usage.

EXIT: Exit the menu.

- **SAVE CURRENT AS USER CONFIG:** Save the current setup as the user default configuration.

Factory Maintain

Factory maintenance function is only available for the service engineers of EDAN or representative authorized by EDAN.

Calibrating NIBP

NIBP is not user-calibrated. NIBP pressure transducers must be verified at least once every two years by a qualified service professional, and calibrated, if necessary. See the Service Manual for details.

4.12 Data Store

The monitor can support the USB storage for the Data Store function. Enter the menu by **SYSTEM MENU > DATA STORE** to set the data storing function. You can set the storing interval, browse data, search data, and delete all the data or single item data.

- ◆ **ON/OFF:** set the Data Store function to **ON** or **OFF**.

Data stored in U disk consists of several folders, when the capacity of each ID folder exceeds 512KB, it will create a new folder and continue to store data. Data quantity depends on the capacity of U disk. When U disk is full, the monitor will prompt an alarm “Disk is not enough.” U disk cannot store waves.

WARNING

- 1 If you want to stop the data storing function, you should set this item to **OFF** before unplugging the USB disk.
 - 2 Do not unplug the USB storage when storing data. If the data damaged by unplugging the USB storage during data storing cannot be deleted on the monitor, the user can delete them on the PC.
-
-

NOTE:

1. If you set the item to **ON**, after restarting the monitor, this item will store data automatically, otherwise you will have to manually store data.
2. If formatting is failed, try again. Restart the monitor and retry the formatting, or contact the service personnel of the manufacturer if formatting is failed repeatedly.

◆ **INTERVAL**: set the storing interval by this item, it can be set to **1S, 5S, 10S, 30S, 1MIN** or **5MIN**.

◆ **MANAGEMENT**: select **BROWSE** to browse data stored before.

— **DELETE ALL**: Select this item to delete all the data stored before. The dialog box displays: **All records will be deleted, OK?**

Select **YES** to delete all the data.

— **UP-DOWN**: Select this item, then turn the page by pressing the UP or DOWN button to browse data.

— **SEARCH**: Search data by patient ID, date and time.

— **RETURN**: Select this item to return to the previous menu.

Select the single item data in **DATA BROWSER** menu; press **OK** to display the f menu.

The user can select to browse the **TREND TABLE, TREND GRAPH** or **ALARM LIST**.

The user can select **DELETE** to delete the single item data; or select the **RETURN** to return to the previous menu.

NOTE:

The data which is being stored cannot be browsed in real time. Before searching data, you should turn off the **Data Store** function at first.

4.13 Sleep Mode

Entering the Sleep Mode

Select **SYSTEM MENU > SYSTEM SETUP > STANDBY** and configure the item to **ON**. Then you will see the dialogue after pressing the switch for less than 1s: **Enter sleep mode, yes?**

Select **YES** to enter the Sleep mode.

NOTE:

When the **SYSTEM SETUP >STANDBY** is **OFF**, or the monitor is in **DEMO** mode, or there is any inputting signal, pressing the **ON/OFF** button cannot make the monitor enter the sleep mode.

Quitting the Sleep Mode

In the sleep mode, if a new signal occurs or you press any button on the front panel, the monitor will enter the working mode.

NOTE:

- 1 If the following situation occurs, monitor will return to normal monitoring mode automatically: The monitor receives physiological signal of SpO₂, and lasts for 5 s; if the monitor is powered by battery, when the battery electric energy is low, it will enter normal monitoring mode, and indicates low battery alarm.
- 2 In DEMO mode, the monitor cannot enter Sleep mode.

Chapter 5 Alarm

This chapter gives general information about the alarm and measures to be taken accordingly.

Alarm setup and prompt messages are provided in respective parameter setup sections.

WARNING

A potential hazard can exist if different alarm presets are used for the same or similar equipment in any single area.

5.1 Alarm Modes

5.1.1 Alarm Level

Each alarm, either technical or physiological, has its own level. For alarm of higher level, when the alarm condition is active, the system will give a prompt in various ways. Alarms in the monitor are divided into three levels: high, medium and low.

High-level alarm indicates the patient's life is in danger or the monitor has serious problem in technical respect. It is the most serious alarm.

Medium-level alarm means serious warning.

Low-level alarm is a general warning.

The monitor provides two types of alarm: physiological alarms and technical alarms. Also, the monitor provides prompts. Physiological alarms refer to those alarms triggered by patient's physiological situation which could be considered dangerous to his or her life. Technical alarm refer to system failure which can make certain monitoring process technically impossible or make monitoring result unbelievable. The monitor can give the character indication of monitoring process or other functions. And this character is called prompts.

The alarm levels for technical alarms and some physiological alarms are pre-set by the system and cannot be changed by the user in most of the cases. But you can alter the alarm level for **SpO₂ SENSOR OFF**. For more information, please refer to *SpO₂ SETUP* in *4.11 Maintain*.

5.1.2 Alarm Modes

When alarm occurs, the monitor can raise the user's attention in at least three ways, which are audio prompt, visual prompt and description.

Audio and visual prompt is given by LCD display device, the speaker on the display device and the alarm indicator. Physiological alarm, Technical Alarm or description is displayed in information area or beside the parameters at the bottom of the screen.

NOTE:

The concrete presentation of each alarm prompt is related to the alarm level.



Screen Display

When the measured parameter exceeds its alarm limits and triggers a physiological alarm, the monitor will give alarm prompt on the screen indicating the occurrence of alarm.

The description will display in Information area, such as “***NS TOO HIGH”, and displays beside the parameter to indicate the low-medium level alarm.



Technical alarm will not prompt * signal.

Alarm Level	Visual Prompt
High	1:  displays in Parameter area 2: *** displays in the information area (Physiological alarm only)
Medium	1:  displays in Parameter area 2: ** displays in the information area (Physiological alarm only)
Low	1:  displays in Parameter area 2: * displays in the information area (Physiological alarm only)

Lamp light

The high/medium/low-level alarms are indicated by the system in following different visual ways:

Alarm Level	Visual Prompt
High	Alarm indicator flashes in red with the frequency of (1.4~2.8) Hz.
Medium	Alarm indicator flashes in yellow with the frequency of (0.4 ~0.8) Hz.
Low	Alarm indicator lights on in yellow.

Alarm Sound

The high/medium/low-level alarms are indicated by the system in following different audio ways:

Alarm Level	Audio Prompt
High	Mode is “beep-beep-beep-----beep-beep, beep-beep-beep-----beep-beep”, which is triggered once every 5 s.
Medium	Mode is “beep-beep-beep”, which is triggered once every 25 s.
Low	Mode is “beep-”, which is triggered once every 30 s.

The sound pressure range for audible alarm signals is from 45 dB to 85 dB.

WARNING

Do not rely exclusively on the audible alarm system for patient monitoring. Adjustment of alarm volume to a low level or off during patient monitoring may result in patient danger. Remember that the most reliable method of patient monitoring combines close personal surveillance with correct operation of monitoring equipment.

NOTE:

- 1 When alarms of different levels occur at the same time, the monitor prompts one of the highest levels.
- 2 If the monitor is powered off and then turned on, the alarm setup can resume to the setup which is set before the power-off.

5.1.3 Alarm Setup

Select the **ALARM SETUP** in the **SYSTEM MENU** to open the submenu.

◆ Alarm setup of each parameter

You can turn **ON** or **OFF** the alarm for each parameter, and set the upper and lower alarm limit for each parameter by **ALM HI** or **ALM LO**.

In the **ALARM SETUP** menu, set the alarm limit for each parameter.

For example: Method to set systolic blood pressure alarm limit for **SYS** alarm:

Step 1: Set the **SYS** alarm to **ON**;

Step 2: Select the **ALM HI** (higher alarm limit of **SYS**), **ALM LO** (lower alarm limit of **SYS**).

The user can press **UP/DOWN** and **OK** to set the menu.

The method for setting the alarm limits of other parameters is the same as **SYS** alarm.

◆ ALM REC and ALM REC TIME

By configuring **ALM REC**, the function of automatically outputting the alarm information in case of any physiological alarm can be enabled or disabled. If the item is **ON**, the monitor will automatically print out the alarm information once any physiological alarm happens. If the item is **OFF**, the monitor will not automatically output the alarm information.

Additionally, if **ALM REC** is **ON**, you can also adjust the recording time of the alarm waveform to be outputted by setting **ALM REC TIME**. Available options are **8s**, **16s** and **32s**.

◆ ALARM RESET

Selecting **ALARM RESET** in **ALARM SETUP**, the function of resetting alarm can be enabled.

After the alarm is reset, the monitor will stop auditory alarm including physiological alarm and technical alarm; the visual alarm indications are still displayed in information area; auditory alarm will prompt if a new alarm occurs.

5.2 Alarm Cause

Alarm occurs when:

1. Physiological alarm is evoked;
2. Technical alarm is evoked;

◆ A. Conditions that activate the parameter alarms:

The measurement value exceeds the alarm limit and the alarm is set to **ON**. Alarms will not be

activated if the alarm is set to **OFF**.

◆ **B. Conditions that activate the system alarms (technical alarm):**



Upon the system error, the monitor prompts alarm immediately.

◆ **C. General alert**

In some circumstances, alerts will behave as physiological alarms in normal senses, we do not regard them as real patient health related items.

5.3 Audio Alarm Paused

To activate the audio alarm paused function, you can select **SYSTEM MENU > MAINTAIN > USER MAINTAIN > OTHER SETUP > ALARM SETUP**, and set **AUDIO ALARM PAUSED** to **60S**, **120S** or **180S** (The default duration of auditory alarm pause is 120S), then press the button  on the front panel to pause audio alarm. During the audio alarm paused status:

- ◆ In the information area, the monitor displays audio alarm off icon  and **AUDIO PAUSED XXX S** with a yellow background.
- ◆ The button  on the front panel always flashes.
- ◆ The audio alarm is paused, and no alarms are sounding.
- ◆ The visual alarm indications are still displayed.
- ◆ Other audible signals are not affected, including beat volume, key volume.

Auditory alarm will resume when you press the button again or the paused time terminates.



When **AUDIO ALARM PAUSED** is set to **OFF**, this function is inactivated. The monitor has no response if you press the button .

NOTE:

If a new alarm occurs during the audio alarm paused status, the new alarm will not be sounding.

5.4 Audio Alarm Off

To activate the audio alarm off function, you can select **SYSTEM MENU > MAINTAIN > USER MAINTAIN > OTHER SETUP > ALARM SETUP**, and set **AUDIO ALARM OFF** to **ON**, then press the button  on the front panel and hold it for more than three seconds to turn off audio alarm. During the audio alarm off status,

- ◆ In the information area, the monitor displays the audio alarm off icon  and **AUDIO ALARM OFF** with a red background.
- ◆ The button  on the front panel flashes in yellow, with frequency of (0.5~1) Hz.

- ◆ The audio alarm is turned off, and no alarms are sounding.
- ◆ The visual alarm indications are still displayed.
- ◆ Other audible signals are not affected, including beat volume, key volume.

Pressing the button  again can resume the audio alarm.

When **AUDIO ALARM OFF** is set to **OFF**, this function is inactivated. The monitor has no response if you press the button .

NOTE:

If a new alarm occurs during the audio alarm off period, the new alarm will not be sounding.

5.5 Alarm Reset

To reset the alarm, you can select **SYSTEM MENU > ALARM SETUP > ALARM RESET**. After resetting the alarm,

- ◆ The audio alarm is turned off, and no alarms are sounding.
- ◆ The visual alarm indications are still displayed.
- ◆ It will not influence the configuration of physiological alarm off, audio alarm paused and audio alarm off status.

NOTE:

If a new alarm occurs after the alarm is reset, the new alarm will be sounding.

5.6 Parameter Alarm

WARNING

- 1 Prior to monitoring, make sure that the alarm limit settings are appropriate for your patient.
- 2 Setting alarm limits to extreme values may cause the alarm system to become ineffective.

The setup for parameter alarms is in the menus. In the **SYSTEM MENU >ALARM SETUP**, you can check and set the alarm limit or alarm status. The setup is isolated from each other.

When a parameter alarm is **OFF**, an icon  displays near the parameter. If the alarms are turned off individually, they must be turned on individually.

For the parameters whose alarm is set to **ON**, the alarm will be triggered when at least one of them exceeds alarm limit. The following actions take place:

1. Alarm message displays on the screen as described in alarm mode;
2. The monitor beeps in its corresponding alarm class and volume;
3. Alarm lamp flashes.

5.7 When an Alarm Occurs

NOTE:

When an alarm occurs, you should always check the patient's condition first.

The alarm message appears in Information area of the screen. It is needed to identify the alarm and act appropriately, according to the cause of the alarm.

1. Check the patient's condition.
2. Identify the cause of the alarm.
3. Identify which parameter is alarming or which alarm is happening.
4. When cause of alarm has been over, check that the alarm is working properly.

You will find the alarm messages for the individual parameter in their appropriate parameter chapters of this manual.

5.8 Testing Alarms

When you switch the monitor on, a self-test is started. The monitor will prompt a “Di” tone that means the audio in self-test is normal. Meantime, you must check that the alarm indicator lights are normal. This indicates that the visible and audible alarm indicators are functioning correctly. For further testing of individual measurement alarms, perform the measurement on yourself or use a simulator. Adjust alarm limits and check that appropriate alarm behavior is observed.

Chapter 6 Trend and Recording

In **SELECTION** submenu, the user can set the displayed contents to waveform, trend table or alarm list which can be printed out via **RECORD**.

6.1 General Information on Recording

A thermal dot matrices recorder with printout paper of 48mm wide is used for the monitor.

Performance of the Recorder:

Set the displayed content via **SYSTEM MENU > SELECTION**, trend table or alarm list. Then print it via **RECORD**.

Press the **RECORD** to print out the currently displayed content. Press the **UP/DOWN** button to page up or down the screen, then press **RECORD** to print it out.

The real-time waveform of 8s can be printed out.

NOTE:

- 1 You can press the **RECORD** on the control panel to stop the current recording process.
- 2 It is suggested that the user should not use the recorder when the low battery displays, or the monitor may be turned off automatically.

6.2 Recorder Operations

Record Paper Requirement

Only standard thermosensitive record paper can be used, otherwise the recorder may not function, the recording quality may be poor, and the thermosensitive printhead may be damaged.

Proper Operation

- ◆ When the recorder is working, the record paper goes out steadily. Do not pull the paper outward with force; otherwise the recorder may be damaged.
- ◆ Do not operate the recorder without record paper.

Paper Out

When **OUT OF PAPER** alarm is displayed, the recorder cannot start. Please insert record paper properly.

Inserting Paper

- ◆ Pull outwards the upper arc part of the recorder casing to release the casing.
- ◆ Insert a new roll of paper into the paper cassette, printing side facing upwards.
- ◆ Ensure proper position and tidy margin.
- ◆ Pull about 2 cm of the paper out, and then close the recorder casing.

NOTE:

Be careful when inserting paper. Avoid damaging the thermo-sensitive print head. Unless when inserting paper or shooting troubles, do not leave the recorder catch open.

Removing Paper Jam

When the recorder functions or sounds improperly, you should open the recorder casing to check for a paper jam. Removing the paper jam in the following way:

- ◆ Cut the record paper from the feeding edge.
- ◆ Open the recorder casing.
- ◆ Re-insert the paper.

6.3 Recorder Alarm Information

Technical Alarm:

Message	Cause	Alarm Level	What to do
Recorder Out Of Paper	Recorder Out Of Paper	Low	Please install the paper.
No Recorder	The user presses the RECORD button when Recorder is not configured.	Low	Notify the manufacturer's service staff to install and set the recorder.

Chapter 7 Maintenance/Cleaning

WARNING

- 1 Failure on the part of the responsible individual hospital or institution employing the use of this equipment to implement a satisfactory maintenance schedule may cause undue equipment failure and possible health hazards.
- 2 If you discover a problem with any of the equipment, contact your service personnel, or your authorized supplier.
- 3 The maintenance operations like software upgrade of the device can only be completed by EDAN's qualified service professionals.

7.1 Inspecting

The overall check of the monitor, including the safety check, should be performed only by qualified personnel every 24 months, and each time after fix up.

The following items should be checked:

- If the environment condition and power supply meet requirement.
- If the power supply cord has damage and insulativity meets requirement.
- If the device and accessories have damage.
- Specified accessories.
- If the alarm system can work properly.
- If the recorder can work properly and the paper meets the requirement.
- Battery performance
- If all monitoring functions are in good conditions.
- If the grounding resistance and leakage current meet requirement.

If any damage or abnormality is found, please don't use the monitor and contact local Customer Service Center.

7.2 Maintenance Task and Test Schedule

Maintenance shall be carried out at least once every two years, or as specified by local regulations. The following tasks are for EDAN-qualified service professionals only. Contact an EDAN-qualified service provider if your monitor needs a safety or performance test. Clean and disinfect equipment to decontaminate it before testing or maintaining it.

Maintenance and Test Schedule	Frequency
Safety checks. Selected tests on the basis of IEC60601-1	At least once every two years, or as needed, after any repairs where the power supply is removed or replaced, or if the monitor has been dropped.

Maintenance and Test Schedule	Frequency
Check all monitoring functions and measuring functions	At least once every two years, or as needed.

7.3 General Cleaning

If the device or accessory has been in contact with the patient, then cleaning and disinfection is required after every use. If there has been no patient contact and there is no visible contamination then daily cleaning and disinfection is appropriate.

The validated cleaning agents for cleaning the monitor and reusable accessories are:

- Mild near neutral detergent
- Ethanol (75%)
- Isopropanol (70%)

Cleaning agents should be applied and removed using a clean, soft, non-abrasive cloth or paper towel.

7.3.1 Cleaning the Monitor

WARNING

Before cleaning the monitor, make sure that the monitor is switched off and disconnected from the power line.

To surface-clean the monitor, follow these steps:

1. Switch off the monitor and disconnect it from the power line.
2. Wipe the entire exterior surface, including the screen, of the equipment using a soft cloth dampened with the cleaning solution thoroughly until no visible contaminants remain.
3. After cleaning, wipe off the cleaning solution with a fresh cloth or towel dampened with tap water until no visible cleaning agent remains.
4. Dry the monitor in a ventilated and cool place.

7.3.2 Cleaning the Reusable Accessories

7.3.2.1 Cleaning the Blood Pressure Cuff

Cleaning the Cuff:

1. Take out the air bladder before cleaning.
2. Hand wash the cuff with the cleaning solution; clean the air bladder with a soft cloth dampened with the cleaning solution. until no visible contaminants remain
3. Rinse the cuff and wipe off the cleaning solution with a fresh cloth or towel, dampened with tap water after cleaning until no visible cleaning agent remains.

4. Wipe off residual moisture with a dry cloth.
5. Air dry the cuff thoroughly after cleaning.

Replacing the Air Bladder:

After cleaning, replace the air bladder into the cuff following the steps below:

1. Roll the bladder lengthwise and insert it into the cuff from the large opening at one end of the cuff.
2. Thread the hose from within the cuff and out through the small hole at the top of the cuff.
3. Adjust the bladder until it is in position.

7.3.2.2 Cleaning the SpO₂ Sensor

1. Wipe the surfaces of the sensor and cable using a soft cloth dampened with the cleaning solution until no visible contaminants remain.
2. Wipe the patient contact area of the sensor with the cotton swab dampened with the cleaning solution. until no visible contaminants remain
3. Wipe off the cleaning solution with a fresh cloth or towel, dampened with tap water after cleaning until no visible cleaning agent remains.
4. Wipe off with a dry cloth to remove residual moisture.
5. Leave the sensor to air dry.

7.3.2.3 Cleaning the TEMP Sensor

1. Wipe the patient contact area with a soft cloth dampened with the cleaning solution until no visible contaminants remain.
2. Wipe off the cleaning solution with a fresh cloth or towel, dampened with tap water after cleaning until no visible cleaning agent remains.
3. Wipe off with a dry cloth to remove residual moisture.
4. Leave the sensor to air dry.

7.3.3 Cleaning the Dust-proof Filter Assembly

The dust-proof filter system is shown as below figure. Through filtering the dust in air and the abnormal objects during deflation, the dust proof filter system can extend the pump's lifetime and reduce the effect of dust on measurement accuracy.

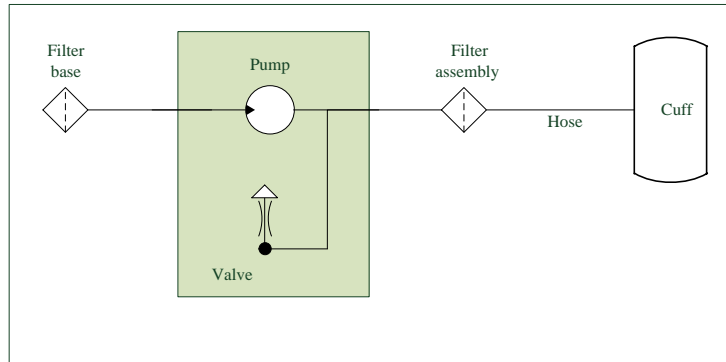

The recommended cleaning frequency is once every month, if the environment is dusty, the frequency may be twice every month, if the sound during inflation is noisier than usual, user needs to clean the dust-proof filter assembly according to the real condition.

To clean the filter base, follow these steps:



1. Switch off the monitor and disconnect it from the power line, open the battery door and take out battery;
2. Put one A6 size paper under the assembly, use a clean and dry cotton swab to clean the filter base, until it is clean;
3. Recycle the paper with dust.

NOTE:

- 1 Don't use wet cotton bud to clean the filter base.
- 2 Disassembling the filter base is prohibited.
- 3 If you need to replace the filter base, please contact EDAN's service personnel.

To clean the filter assembly, follow these steps:

1. Turn on the monitor, and set patient type as Adult;
2. Disconnect the extend cable and NIBP cuff ;

3. Press the  button on front panel to inflate, the abnormal objects in the dust proof filter assembly will be blown out, if there is still abnormal object, press  button again to repeat.

NOTE:

- 1 The dust proof filter assembly is designed in the device, users can't disassemble the device to clean.
- 2 If you need to replace the dust proof filter assembly, please contact EDAN's service personnel.

7.4 Disinfection

For devices or accessories that have been in contact mucosal surface, High Level disinfection must occur, for all other accessories, low level disinfection is appropriate. Clean the monitor and reusable accessories before they are disinfected. The validated disinfectants for cleaning the monitor and reusable accessories are:

- Ethanol (75%)
- Isopropanol (70%)
- Cidex OPA (High level disinfection of intracavitary temperature probe only)

If Ethanol or Isopropanol is used for both cleaning and disinfecting, then a new cloth is required to be used for the disinfection step.

WARNING

The monitor and reusable accessories shall be disinfected to avoid patient cross infection.

CAUTION

- 1 Do not use any disinfectant containing additional active ingredients other than those listed, such as disinfectant didecyl dimethyl ammonium bromide which contains quaternary ammonium salt.
 - 2 Although the monitor is chemically resistant to most common hospital cleaners, disinfectants and non-caustic detergents, different cleaners or disinfectants are not recommended and may stain the monitor, such as disinfectant didecyl dimethyl ammonium bromide which contains quaternary ammonium salt.
-
-

7.4.1 Disinfecting the Monitor

WARNING

Before disinfecting the monitor, make sure that the monitor is switched off and disconnected from the power line.

To disinfect the monitor, follow these steps:

1. Switch off the monitor and disconnect it from the power line.
2. Wipe the display screen using a soft, clean cloth dampened with the disinfectant solution.
3. Wipe the exterior surface of the equipment using a soft cloth dampened with the disinfectant solution.
4. Wipe off the disinfectant solution with a dry cloth after disinfection if necessary.
5. Dry the monitor for at least 30 minutes in a ventilated and cool place.

7.4.2 Disinfecting the Reusable Accessories

7.4.2.1 Disinfecting the Blood Pressure Cuff

Disinfecting the Cuff:

1. Take out the air bladder before disinfection.
2. Wipe the cuff and the air bladder with a soft cloth dampened with the disinfectant solution.
3. Leave the cuff and air bladder to air dry for at least 30 minutes.

NOTE:

Prolonged use of disinfectant may cause discoloration of the cuff.

Replacing the Air Bladder:

After disinfection, replace the air bladder into the cuff. Refer to Section 7.3.2.1 for more information.

7.4.2.2 Disinfecting the SpO₂ Sensor

1. Wipe the surfaces of the sensor and cable using a soft cloth dampened with the disinfection solution.
2. Wipe the patient contact area of the sensor with the cotton swab dampened with the disinfection solution.
3. Wipe off the disinfection solution with a dry cloth after disinfection.
4. Leave the sensor to air dry for at least 30 minutes.

7.4.2.3 Disinfecting the TEMP Sensor

The intracavitary TEMP sensors should be reprocessed by high-level disinfection before and after use on each new patient. Cidex OPA is the validated agent for high level disinfection. Refer to the instructions of the disinfectant for the methods of disinfection. High level disinfection has been validated with a 12 minute soak. Rinse and dry according to the labeled instructions of Cidex OPA. Do not dampen the sensor connector.

For the skin TEMP sensors, disinfect them as follows using ethanol or isopropanol only:

1. Wipe the patient contact area with a soft cloth dampened with the disinfectant solution (ethanol or isopropanol).
2. Wipe off the disinfectant solution with a dry cloth after disinfection.
3. Leave the sensor to air dry.

7.5 Replacement of Fuse

Unscrew the fuse cap anticlockwise, replace the fuse (protector tube) and screw down the fuse cap clockwise. Fuse size: $\Phi 5 \times 20$, Rated value: T2.0 AH250 VP.

NOTE:

Switch off the power of the monitor before examining the fuse.

7.6 Cleaning Battery and Battery Compartment Cover

Use only non-caustic detergents such as soap and warm water (40 °C /104 °F maximum) to clean the battery. Do not use strong solvent to clean battery, and do not dip the battery in liquid.

Chapter 8 SpO₂ Monitoring (Optional)

8.1 Overview

SpO₂ is used to measure arterial blood oxygen saturation, which is the percentage of oxyhemoglobin in the arterial blood. SpO₂ parameter can also provide pulse rate (PR) and a plethysmogram wave (Pleth).

8.2 SpO₂ Safety Information

WARNING

- 1 Do not use the SpO₂ sensors if the packaging or the sensor is damaged and return them to the vendor.
 - 2 If the SpO₂ sensor cannot work properly, please reconnect the sensor or change a new one.
 - 3 Correct and proper sensor application: if the sensor is too loose, it might compromise the optical alignment, and even cause the sensor to fall off. If the sensor is too tight, (such as the application site is too large or becomes too large due to edema), excessive pressure and local tissue ischemia, hypoxia and lack of nutrition may occur on the application site. Prolonged and continuous monitoring may increase the risk of Skin irritations or lacerations. To avoid these damages, users should periodically check surrounding skin of application site according to the patient's condition and pressure sensor, inspect the if there is sign of stress-related damage in surrounding tissue, and regularly change the application site. For the patients whose fluid is easy to transfer and/or the patients with systemic or localized edema, users should inspect the skin and change application site more frequently.
 - 4 Use only EDAN permitted sensors and extension cables with the monitor. Other sensors or extension cables may cause improper monitor performance and/or minor personal injury.
 - 5 High oxygen levels may predispose a premature infant to retrolental fibroplasia. If this is a consideration do NOT set the high alarm limit to 100%, which is equivalent to switching the high limit alarm off.
 - 6 When serious arrhythmia is present, the SpO₂ pulse rate may differ from ECG heart rate but this does not indicate an inaccurate PR (SpO₂) value.
-
-

NOTE:

- 1 Avoid placing the sensor on extremities with an arterial catheter, or intravascular venous infusion line.
- 2 When a trend toward patient deoxygenation is indicated, analyze the blood samples with a laboratory co-oximeter to completely understand the patient's condition.
- 3 SpO₂ waveform is not directly proportional to the pulse volume.
- 4 The device is calibrated to display functional oxygen saturation.

- 5 A Functional tester or simulator cannot be used to assess the SpO₂ accuracy. However, it can be used to demonstrate that a particular monitor reproduces a calibration curve that has been independently demonstrated to meet a particular accuracy.
- 6 If the surrounding temperature increases, the operator should pay attention to the site of poor perfusion, and increase the frequency of checking the skin and changing the measurement site to prevent burns. If the initial skin temperature is less than 35 °C, the temperature of all the listed sensors on the skin will not exceed 41 °C during working.
- 7 The cumulative use time for the single-patient SpO₂ sensor in a single patient should be less than 30 days.

8.3 Measuring SpO₂

1. Select the correct patient category setting (adult/pediatric and neonatal), as this is used to optimize the calculation of the SpO₂ and pulse numeric.
2. During measurement, ensure that the application site:
 - has a pulsatile flow, ideally with a good circulation perfusion.
 - has not changed in its thickness, causing an improper fit of the sensor.

Measurement Procedure

1. Switch on the monitor.
2. Attach the sensor to the appropriate site of the patient finger.
3. Plug the connector of the sensor extension cable into the SpO₂ socket on the SpO₂ module.

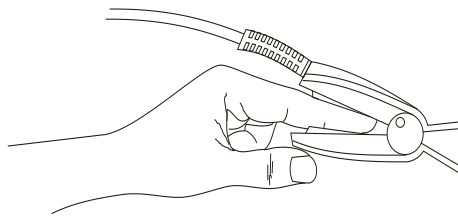

Mounting of the Sensor

WARNING

Inspect the application site every two to three hours to ensure skin quality and correct optical alignment. If the skin quality changes, move the sensor to another site. Change the application site at least every four hours. For neonate, change the measuring site every 20 minutes.

NOTE:

- 1 Injected dyes such as methylene blue or intravascular dyshemoglobins such as methemoglobin and carboxyhemoglobin may lead to inaccurate measurements.

- 2 Inspect the sensor to ensure that the light emitter and receiver are aligned with each other and there is no gap between the sensor and the finger. All the light emitted by the light emitter must pass through the patient's tissue. The sensor cable should be placed on the back of the hand.
- 3 Clean and remove any substances such as nail polish from the application site. Periodically check to ensure that the sensor remains properly positioned on the patient.

8.4 Measurement Limitations

Certain patient conditions can affect the measurements and cause the loss of the pulse signal.

Inaccurate measurements can be caused but not limited by:

- incorrect sensor application
- high levels of ambient light sources, such as surgical lights (especially those with a xenon light source), bilirubin lamps, fluorescent lights, infrared heating lamps, and direct sunlight
- failure to cover the sensor with opaque material in high levels of ambient light conditions
- dysfunctional hemoglobins
- low peripheral perfusion
- excessive or violent patient movement
- venous pulsations
- intravascular dyes, such as indocyanine green or methylene blue
- externally applied coloring agents (nail polish, dye, pigmented cream)
- defibrillation
- placement of the sensor on an extremity with a blood pressure cuff, arterial catheter, or intravascular line
- electromagnetic interference

Loss of pulse signal can occur for the following reasons:

- the sensor is applied too tightly
- a blood pressure cuff is inflated on the same extremity as the one with the sensor attached
- there is arterial occlusion proximal to the sensor
- low peripheral perfusion

NOTE:

- 1 To prevent interference from ambient light, ensure that the sensor is properly applied, and cover the sensor site with opaque material.
- 2 Adjacent SpO₂ sensors may interfere with each other (eg, multiple SpO₂ measurements in the same patient). Be sure to cover the sensor with opaque material to reduce cross-interference.

- 3 Move the sensor to a less active site, and keep the patient still, if possible.
- 4 For Nellcor SpO₂ module, the algorithm automatically extends the amount of data required for measuring SpO₂ and PR depending on the measurement conditions. During normal measurement conditions the averaging time is 6 to 7 seconds. During conditions such as those caused by low perfusion, interference (e.g., external interference such as ambient light or patient movement), or a combination of these, the algorithm automatically extends the amount of data required beyond 7 seconds. If the resulting dynamic averaging time exceeds 20 seconds, the screen will display prompt message "Search Pulse" and SpO₂ and PR will continue to be updated every second. As these conditions extend, the amount of data required continues to increase. If the dynamic averaging time reaches 40 seconds, the screen will display high-level alarm message "No Pulse" indicating a loss-of-pulse condition.

8.5 Assessing the Validity of a SpO₂ Reading

You can check the quality of the pleth wave and the stability of the SpO₂ values to assess whether the sensor functions properly and whether the SpO₂ readings are valid. Always use these two indications simultaneously to assess the validity of a SpO₂ reading.

Generally, the quality of the SpO₂ pleth wave reflects the quality of the light signals obtained by the sensor. A wave of poor quality manifests a decline of the signal validity. On the other hand, the stability of the SpO₂ values also reflects the signal quality. Different from varying SpO₂ readings caused by physiological factors, unstable SpO₂ readings are resulted from the sensor's receiving signals with interference. The problems mentioned above may be caused by patient movement, wrong sensor placement or sensor malfunction. To obtain valid SpO₂ readings, try to limit patient movement, check the placement of the sensor, measure another site or replace the sensor.

NOTE:

- 1 The SpO₂ accuracy has been validated in controlled human studies against arterial blood sample reference measured with a CO-oximeter. SpO₂ measurements are statistically distributed, only about two-thirds of the measurements can be expected to fall within the specified accuracy compared to CO-oximeter measurements. The volunteer population in the studies composed of healthy men and women from age 19 to 37(for EDAN SpO₂ module), from 18 to 50 (for Nellcor SpO₂ module), with various skin pigmentations. Note that the study population was healthy adults and not in the actual intended use population.
- 2 The pulse rate accuracy is obtained by comparison to the pulse rate generated with an arterial oxygen simulator (also an electronic pulse simulator).
- 3 During monitoring, if the monitor's reading differs significantly from the patient's physiological condition, it indicates that the signal may be disturbed, resulting in an inaccurate reading. In this case, the artifact can disguise as a similar reading, causing the monitor to fail to send an alarm. In order to ensure reliable monitoring, it is necessary to regularly check whether the sensor is wearing properly and the signal quality is good.

8.6 SpO₂ Alarm Delay

There is a delay between a physiological event at the measurement site and the corresponding alarm at the monitor. This delay has two components:

1. The time between the occurrence of the physiological event and when this event is represented by the displayed numerical values. This delay depends on the algorithmic processing time and the sensitivity. The lower the sensitivity configured, the longer the time needed until the numerical values reflect the physiological event.
2. The time between the displayed numerical values exceeding an alarm limit and the alarm indication on the monitor. This delay is the combination of the configured alarm delay time plus the general system delay time.

8.7 Perfusion Index (PI)*

*** Only applicable to the EDAN SpO₂ module.**

PI is a numeric value indicating perfusion level. It reflects the perfusion level at the monitoring site.

As the measurement of SpO₂ is based on the pulsation caused by the blood flow through the vessel, PI is in relation to the strength of the pulse. Also, you can use PI as a signal quality indicator for the measurement of SpO₂.

PI is indicated by a value ranging from 0 to 10. The bigger the value is, the better the perfusion and the signal quality will be. The perfusion level and the signal quality are at their maximum when the value reaches 10. When PI is below 2, it indicates the low perfusion and the poor signal quality at the monitoring site; you need to reposition the sensor or find a better site.

The PI value will be displayed on the SpO₂ waveform area.

8.8 SatSeconds Alarm Management*

*** Only applicable to the Nellcor SpO₂ module. Not applicable to MFM-CMS**

8.8.1 Describing SatSeconds

With traditional alarm management, upper and lower alarm limits are set for monitoring oxygen saturation. During monitoring, as soon as an alarm limit is violated by as little as one percentage point, an alarm is immediately triggered. When the SpO₂ level fluctuates near an alarm limit, the alarm is triggered each time the limit is violated. Such frequent alarms can be distracting.

With the SatSeconds technique, upper and lower SpO₂ alarm limits are set in the same way as traditional alarm management. However, you can also set a SatSeconds limit that allows monitoring of SpO₂ below the selected lower alarm limit and above the selected upper alarm limit for a period of time before an alarm is triggered.

The method of calculation is as follows:

The number of percentage points that the SpO₂ falls outside the alarm limit is multiplied by the number of seconds that the SpO₂ level remains outside that limit. This can be stated as an equation:

Points × Seconds = SatSeconds

Where:

Points = SpO₂ percentage points outside of the limit

Seconds = number of seconds that SpO₂ remains at that point outside of the limit

The alarm response time, assuming a SatSeconds limit set at 50 and a lower alarm limit set at 90, is described and illustrated below.

In this example, the SpO₂ level drops to 88 (2 points below the limit) and remains there for a period of 2 seconds (2 points × 2 seconds = 4 SatSeconds). The SpO₂ then drops to 86 for 3 seconds and then to 84 for 6 seconds. The resulting SatSeconds values are shown below:

SpO ₂		Seconds		SatSeconds
2	×	2	=	4
4	×	3	=	12
6	×	6	=	36
Total SatSeconds			=	52

After approximately 10.7 seconds, a SatSeconds alarm will be triggered, because the limit of 50 SatSeconds has been exceeded. See arrow (↑) in the following figure.

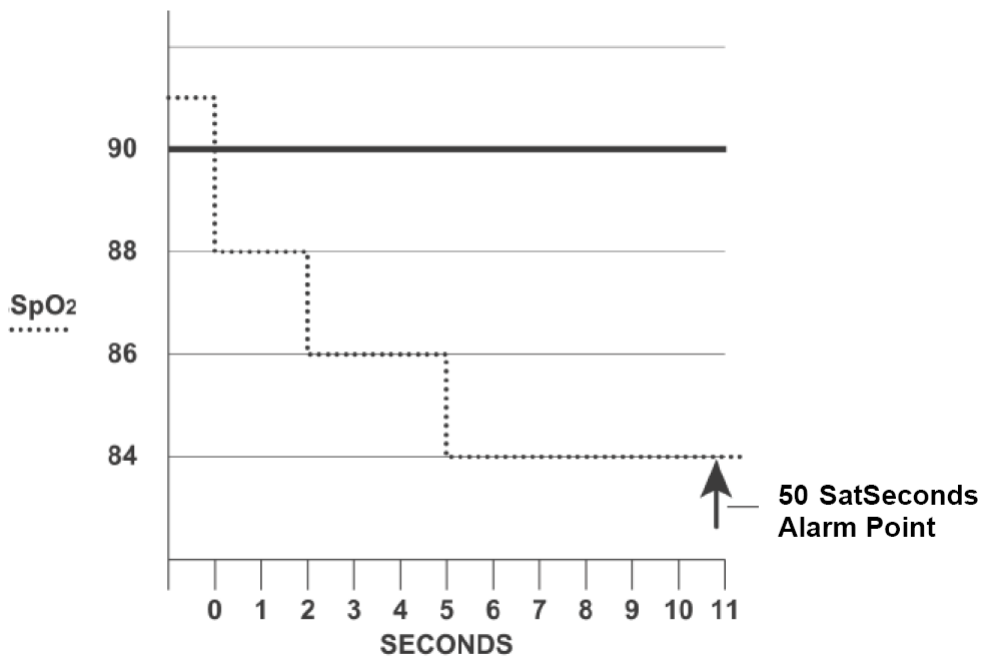

Alarm Response with SatSeconds

Saturation levels may fluctuate rather than remaining steady for a period of several seconds. Often, the patient SpO₂ may fluctuate above and below the alarm limit, re-entering the non-alarm range several times. During such fluctuation, the monitor integrates the number of SpO₂ points, both positive and negative, until either the SatSeconds limit is reached, or the patient SpO₂ returns within a normal range and remains there.

8.8.2 SatSeconds “Safety Net”

The SatSeconds “Safety Net” is for patients whose saturation makes frequent excursions below or above the SpO₂ limit but does not remain in violation long enough for the SatSeconds limit to be reached. If three or more SpO₂ alarm limit violations occur within a 60-second period, an alarm will be triggered even if the SatSeconds limit has not been reached.

8.8.3 Setting SatSeconds Duration

You can set **SatSeconds** to **Off** or to the duration among **10**, **25**, **50** and **100**. To configure the SatSeconds settings, enter the **SpO₂ Setup** menu and select the desired SatSeconds setting from the **SatSeconds** list.

8.9 Alarm

8.9.1 Adjustable Range of Alarm Limits

SpO₂/ PR adjustable range of alarm limits:

	Adjustable Range
SpO ₂	0~100
PR	30~300

Default SpO₂ alarm limits:

	Max. Upper Limit	Min. Lower Limit	Step
ADU	100	90	1
PED	100	90	1
NEO	95	88	1

Default PR alarm limits:

	Max. Upper Limit	Min. Lower Limit	Step
ADU	120	50	1
PED	160	75	1
NEO	200	100	1

8.9.2 Alarm Information and Prompts

Physiological alarm:

Message	Cause	Alarm Level
SpO₂ HIGH	SpO ₂ measuring value is above upper alarm limit.	Medium
SpO₂ LOW	SpO ₂ measuring value is below lower alarm limit.	Medium
PR HIGH	PR measuring value is above upper alarm limit.	Medium
PR LOW	PR measuring value is below lower alarm limit.	Medium

Message	Cause	Alarm Level
NO PULSE	The signal of the measurement site is too weak due to insufficient blood supply and environmental factors, so the monitor can't detect the pulse signal.	High

Technical alarms:

Message	Cause	Alarm Level	What to do
SpO₂ SENSOR OFF	SpO ₂ sensor may be disconnected from the patient or the monitor.	Low	Make sure the sensor is well connected to the patient's finger or other parts. Make sure the monitor and cables are well connected.
SpO₂ COMM STOP	SpO ₂ module failure or communication failure	High	Stop using measuring function of SpO ₂ module; notify biomedical engineer or manufacturer's service staff.
SpO₂ LOW PERFUSION	The pulse signal is too weak or the perfusion of the measurement site is too low. The SpO ₂ value and PR value might be inaccurate then.	Low	Reconnect the sensor, or choose another measured position. If the problem remains, please notify biomedical engineer or manufacturer's service staff.
NO SpO₂ SENSOR	SpO ₂ sensor was not connected well or connected to the monitor, or the connection is loose.	Low	Reconnect the sensor with the monitor. Make sure the monitor is well connected with the cable.
SpO₂ NOISY SIGNAL	There is interference with SpO ₂ measurement signals due to patient movement, ambient light, electrical interference or else.	Low (EDAN Module)	Check the condition of patient and avoid patient movement; make sure the cable is well connected.
SpO₂ Sensor Err.	Malfunction in the SpO ₂ sensor or in the extension cable.	Low	Replace the SpO ₂ sensor or the extension cable.

Message	Cause	Alarm Level	What to do
SpO₂ Interference	Ambient light around the sensor is too strong.	Low	Reduce interference of the ambient light and avoid sensor's exposure to strong light.

Prompts:

Message	Cause
SEARCH PULSE	SpO ₂ sensor may be disconnected from the patient or the monitor.
SpO₂ NOISY SIGNAL	There is interference with SpO ₂ measurement signals due to patient movement, ambient light, electrical interference or else.(Nellcor Module)

Chapter 9 NIBP Monitoring (Optional)

9.1 Overview

This monitor uses the oscillometric method for measuring NIBP. It can be used for adult, pediatric and neonatal patients. It is also intended for use with pregnant, including pre-eclamptic patients.

Oscillometric devices measure the amplitude of pressure changes in the occluding cuff as the cuff deflates from above systolic pressure. The amplitude suddenly increases as the pulse breaks through the occlusion in the artery. As the cuff pressure decreases further, the pulsations increase in amplitude, reach a maximum (which approximates to the mean pressure), and then diminish.

The blood pressure measurements determined with this device comply with the American National Standard for Electronic or Automated Sphygmomanometers (ISO 81060-2:2013) in relation to mean error and standard deviation. In clinical investigation method with a reference sphygmomanometer, the fifth Korotkoff sound was used to determine adult diastolic pressure, and the fourth Korotkoff sound was used to determine pediatric diastolic pressure.

9.2 NIBP Safety Information

WARNING

- 1 Do not measure NIBP on patients with sickle-cell disease or any condition where skin damage has occurred or is expected.
 - 2 Do not measure NIBP on the arm of the same side with a mastectomy.
 - 3 Use clinical judgment to decide whether to perform frequent blood pressure measurements on patients with severe blood clotting disorders because of the risk of hematoma in the limb fitted with the cuff.
 - 4 Do not apply the cuff to a limb that has an intravenous infusion or catheter in place. This could cause tissue damage around the catheter when infusion is slowed or blocked during cuff inflation.
 - 5 Do not attach the cuff to a limb being used for IV infusions as the cuff inflation can block the infusion, potentially causing harm to patient.
 - 6 Do not apply the cuff to a limb where intravascular access or therapy, or an arterio-venous (A-V) shunt is present, otherwise, it may result in injury to the patient.
 - 7 Ensure that the correct patient type is selected before performing measurements. Do not apply the higher adult inflation, overpressure limits and measurement duration for neonatal patients. Not using the neonate mode on a neonatal patient can block the blood flow, potentially causing harm to the patient.
 - 8 Make sure that the air conduit connecting the blood pressure cuff and the monitor is neither blocked nor tangled.
 - 9 Measuring of blood pressure can temporarily cause malfunctioning of other medical monitoring devices on the same limb.
-
-

WARNING

- 10 NIBP readings can be affected by the measurement site, the position of the patient, exercise, or the patient's physiologic conditions.
 - 11 Continuous cuff pressure due to connection tubing kinking can block the blood flow, and may result in injury to the patient.
 - 12 Verifying the calibration is only applicable for adults, and it cannot be operated in automatic measuring interval. Continuous measuring cannot be operated in automatic measuring interval either.
-

NOTE:

- 1 It is suggested that the user should not start NIBP measuring when the low battery displays, or the monitor may be turned off automatically.
- 2 If you spill liquid onto the equipment or accessories, particularly if there is a chance that it can get inside the tubing or the measurement device, contact your service personnel.
- 3 Continuous use of the automatic measuring mode for short intervals may lead to the discomfort of patient. Continuous measuring and automatic measuring in neonatal or pediatric mode may result in tissue damage or ischemia to the patient.
- 4 NIBP measurement can be affected by extremes of temperature, humidity and altitude.
- 5 NIBP measurement value should be explained by qualified professionals.
- 6 The pulse rate based on the NIBP measurement may differ from the heart rate based on the ECG waveform. NIBP measures the number of peripheral pulse pulsations, and the heart rate is measured by the electrical signal of the heart. When the electrical signals of the heart occasionally fail to cause the peripheral blood vessels or the patient's peripheral perfusion is poor, the difference happens.
- 7 The cumulative use time for the single-patient NIBP cuff in a single patient should be less than 30 days.

9.3 Measurement Limitations

Measurements are impossible with pulse rate extremes of less than 40 bpm or greater than 240 bpm, or if the patient is on a heart-lung machine.

The measurement may be inaccurate or impossible in the following situations:

- A regular arterial pressure pulse is hard to detect.
- Patients with cardiac arrhythmias.
- Patients with excessive and continuous movement such as shivering or convulsions.
- Patients with rapid blood pressure changes.
- Patients with severe shock or hypothermia that reduces blood flow to the peripheries.

- Patients with obesity, where a thick layer of fat surrounding a limb dampens the oscillations coming from the artery.
- Patients on an edematous extremity.

9.4 NIBP Monitoring

To obtain accurate measurements, the following operating steps need to be observed:

1. Ensure the patient position in normal use, including
 - ◆ Comfortably seated or lie flat, legs uncrossed;
 - ◆ Feet flat on the floor;
 - ◆ Back and arm supported;
 - ◆ Middle of the cuff at the level of the right atrium of the heart;
 - ◆ During the measurement, relax as much as possible, neither talking nor applying external pressure against the cuff.
2. Plug in the air hose and switch on the system.

Apply the blood pressure cuff to the patient's arm or leg following the instructions below.

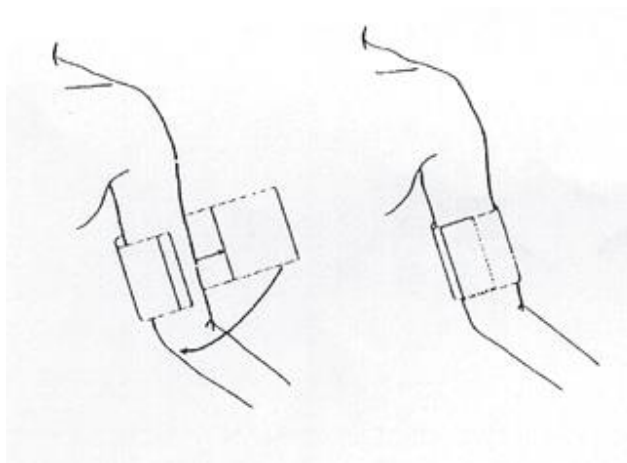

Cuff Usage

- ◆ Ensure that the cuff is completely deflated.
 - ◆ Apply the appropriate size cuff to the patient (About the cuff size selection, please refer to Section *Accessories*), and make sure that the symbol "Φ" is over the artery. Ensure that the cuff is not wrapped too tightly around the limb. Excessive tightness may cause discoloration and eventual ischemia of the extremity.
3. Check whether the patient type is appropriately selected. Access **PATIENT SETUP** menu from **SYSTEM MENU** and pick **PAT TYPE** item and select the required patient type.
 4. Select a measurement mode in the **NIBP SETUP** menu. Pick the **INTERVAL** item for **MANUAL** or set the interval for auto measurement; or select the **CONTINUAL** mode.
 5. Press the **NIBP START/STOP** on the front panel to start a measurement. You can also stop this measurement by this button.

WARNING

Prolonged non-invasive blood pressure measurements in automatic mode may be associated with purpura, ischemic and neuropathy in the limb wearing the cuff. When monitoring a patient, examine the extremities of the limb frequently for normal color, warmth and sensitivity. If any abnormality is observed, stop the blood pressure measurements.

NOTE:

- 1 The width of the cuff is either approximately 40% of the limb circumference or 2/3 of the upper arm length. The inflatable part of the cuff should be long enough to encircle 80%-100% of the limb. The wrong size of cuff can cause erroneous readings. If the cuff size is in question, use another cuff with suitable size to avoid errors.
- 2 If an NIBP measurement is suspect, repeat the measurement. If you are still uncertain about the reading, use another method to measure the blood pressure.
- 3 Please make sure the cuff is well connected. A leak of air may cause measurement error.
- 4 Please select the cuff with the suitable size. An unsuitable cuff may cause incorrect measurements.
- 5 Avoid incursion of liquid into the cuff. If this happens, please desiccate the cuff completely.

9.4.1 Operation Prompts

1. To start auto measurement:

Access **NIBP SETUP** menu and pick the **INTERVAL** item, in which the user may set up the time interval for auto measurement. After that, press the **NIBP START/STOP** on the front panel to start the auto measurement according to the selected time interval.

2. To stop auto measuring:

During auto measuring, press the **NIBP START/STOP** on the front panel at any time to stop the auto measurement in process.

WARNING

If you repeatedly use **AUTO** measuring in a short term, it may lead to inaccurate readings or endanger patient's life.

3. To start a manual measuring:

- Access **NIBP SETUP** menu and pick the **INTERVAL** item. Select the **MANUAL** selection. Then press the **NIBP START/STOP** on the front panel to start a manual measurement.

4. To start a continuous measuring:

Access the **NIBP SETUP** menu and pick the **CONTINUAL** item to start a continuous measurement. The continuous measurement will last 5 min.

5. To stop measuring:

During measuring press the **NIBP START/STOP** on the front panel at any time to stop measurement.

9.4.2 Correcting the Measurement if Limb is not at Heart Level

To correct the measurement if the limb is not at heart level to the displayed value:

Add 0.75 mmHg (0.10 kPa) for each centimeter higher or	Deduct 0.75 mmHg (0.10 kPa) for each centimeter lower or
Add 1.9 mmHg (0.25 kPa) for each inch higher	Deduct 1.9 mmHg (0.25 kPa) for each inch lower

9.5 NIBP Setup

Select **SYSTEM MENU > NIBP SETUP** and you will see the menu:

- ◆ **INTERVAL**: Set it to **MANUAL**, **AVG** or **1/2/3/4/5/10/15/30/60/90/120/240/480** min. When **Interval** is set to **AVG**, the monitor provides the result by averaging the values obtained from three or five times of NIBP measurement.
- ◆ **STAT**

Once this item is selected, the menu will automatically exit from the screen and the monitor will perform continuous measurement immediately.

9.6 Alarm

9.6.1 Adjustable Range of Alarm Limits

The adjusting range of NIBP alarm limits:

Adult Mode

SYS 40 mmHg ~270 mmHg

DIA 10 mmHg ~215 mmHg

MAP 20 mmHg ~235 mmHg

Pediatric Mode

SYS 40 mmHg ~230 mmHg

DIA 10 mmHg ~180 mmHg

MAP 20 mmHg ~195 mmHg

Neonatal Mode

SYS 40 mmHg ~ 135 mmHg

DIA 10 mmHg ~ 100 mmHg

MAP 20 mmHg ~ 110 mmHg

Default NIBP alarm limits:

	ADU (mmHg)		PED (mmHg)		NEO (mmHg)	
	Lower Limit	Upper Limit	Lower Limit	Upper Limit	Lower Limit	Upper Limit
SYS	90	160	70	120	40	90
DIA	50	90	40	70	20	60
MAP	60	110	50	90	25	70

When the monitor is configured to NIBP only measuring mode, the PR is displayed in the **ALARM SETUP** menu.

The range of PR alarm limit:

	Max. Upper Limit (bpm)	Min. Lower Limit (bpm)	Step (bpm)
PR	240	40	1

Default PR alarm limit:

	Max. Upper Limit (bpm)	Min. Lower Limit (bpm)	Step (bpm)
ADU	120	50	1
PED	160	75	1
NEO	200	100	1

9.6.2 Alarm Information and Prompts

Physiological alarms:

Message	Cause	Alarm Level
NS HIGH	NIBP SYS measuring value is above upper alarm limit.	Medium
NS LOW	NIBP SYS measuring value is below lower alarm limit.	Medium
ND HIGH	NIBP DIA measuring value is above upper alarm limit.	Medium
ND LOW	NIBP DIA measuring value is below lower alarm limit.	Medium
NM HIGH	NIBP MAP measuring value is above upper alarm limit.	Medium
NM LOW	NIBP MAP measuring value is below lower alarm limit.	Medium

Technical alarms: (display in the area below the NIBP value):

Message	Cause	Alarm Level	What to do
NIBP COMM ERR	NIBP module failure or communication failure.	High	Stop using measuring function of NIBP module; notify biomedical engineer or Manufacturer's service staff.
LOOSE CUFF	Cuff is not properly wrapped or no cuff is connected.	Low	Properly wrap the cuff
AIR LEAK	NIBP pump, valve, cuff or tube has a leakage.	Low	Check the connections and the wrapped cuff to see whether they are all prepared well.
NIBP PRESSURE ERROR	Decline of air pressure is less than 2 mmHg after 6 deflations.	Low	Check whether the airway is occluded or pressure sensor works properly in pressure meter mode. If the problem still exists, contact your service personnel.
WEAK SIGNAL	Cuff is too loose or patient pulse is too weak.	Low	Use other method to measure blood pressure.
NIBP Range Exceeded	Maybe the patient blood pressure value is beyond the measurement range.	High	Use other method to measure blood pressure.
NIBP NOISE SIGNAL	Because of arm motion, signal noise is too large or pulse rate is not regular.	Low	Make sure that the patient under monitoring is motionless.
NIBP Self Test Error	Sensor or other hardware errors.	High	If failure persists, stop using measuring function of NIBP module and notify biomedical engineer or manufacturer's service staff.
INIT PRESSURE TOO HIGH	The initial pressure is too high during measuring	Low	Measure again, if failure persists, stop using measuring function of NIBP module and notify biomedical engineer or manufacturer's service staff.
NIBP System Failure	NIBP is not calibrated.	Low	Contact your service personnel.

Message	Cause	Alarm Level	What to do
OVER PRESSURE	Pressure has exceeded the specified upper safety limit.	Low	Measure again, if failure persists, stop using measuring function of NIBP module and notify biomedical engineer or manufacturer's service staff.
NIBP SECONDARY OVER PRESSURE	Secondary over pressure protection	High	Notify biomedical engineer or manufacturer's service staff.
CUFF TYPE ERR	The cuff type used isn't consistent with the patient type.	Low	Confirm the patient type and change the cuff.
NIBP TIME OUT	Measuring time has exceeded the specified time.	Low	Measure again or use other measuring method.

Prompt message: (display in the prompt area below NIBP value):

Message	Cause
Manual measuring...	During manual measuring mode.
Continual Measuring	In continuous measuring mode.
Auto measuring...	During automatic measuring mode.
Measurement over	Measurement over
Calibrating...	During calibrating
Calibration over	Calibration over
Leak testing...	During leakage test
Leak test over	Leakage test is over
Resetting...	NIBP module in resetting

Chapter 10 TEMP Monitoring (Optional)

10.1 TEMP Monitoring with T2 Module

10.1.1 Introduction

M3 with the T2 module takes a temperature in either Predict or Monitor Mode. In the Predict mode, the monitor measures oral/axillary/rectal TEMP in a short time, calculates and gets the measuring results. In Monitor mode, it can monitor patient for 10 min. The Oral/Axillary sensor and Rectal sensor are of standard configuration.

The monitor can only measure temperature of adult and pediatric patients. If the user measure temperature of neonate patient, the monitor will not display data.

Making a TEMP Measurement

- ◆ Select the correct sensor according to the measuring position and patient type.
- ◆ Apply the sensor to the patient. You are advised to use a protective rubber cover on sensor.
- ◆ Ensure the alarm settings (on or off, higher alarm or lower alarm limit) are appropriate for the patient and the type of temperature measurement.
- ◆ Select the correct measuring position in menu.
- ◆ Switch on the monitor.
- ◆ It takes 5min for the body temperature to stabilize.

WARNING

- 1 To ensure optimal accuracy, always confirm that the correct mode and alarm limit are selected. Changing the measure position may lead to the change of alarm limit.
 - 2 Verify probe cables fault detection before the beginning of monitoring phase. Unplug the temperature probe cable from the socket, and then the screen will display the error message **TEMP SENSOR OFF** and the audible alarm is activated.
 - 3 Take the TEMP probe and cable carefully. When they are not in use, you should coil up the probe and cable into a loose circle. If the wire inside the cable is tensely pulled, it may cause mechanical damage to the probe and the cable.
 - 4 Verification of the temperature module is necessary as frequently as dictated by your Hospital Procedures Policy. When you need to calibrate the temperature measurement, please contact the manufacturer.
 - 5 Patient actions may interfere with accurate oral temperature readings. Ingesting hot or cold liquids, eating food, chewing gum or mints, brushing teeth, smoking or performing strenuous activity may affect temperature readings for up to 20min after activity has ended.
-

WARNING

- 6 Do not take an axillary temperature through patient's clothing. Direct probe cover to skin contact is required.
- 7 Biting the sensor tip while taking a temperature may result in damage to the sensor.
- 8 Use disposable TEMP sensor covers recommended by EDAN to limit patient cross-contamination. The use of any other probe cover may produce temperature measurement errors or result in inaccurate readings.
- 9 Temp measurement isn't suitable for use during defibrillation.
- 10 In monitoring mode, no physiological alarms are available.

NOTE:

The cumulative use time for the oral or rectal temperature probe in a single patient should be less than 24 hours.

10.1.2 Measuring Procedure

Ensure the sensor is well installed. The icon indicating measuring position flashes in TEMP parameter area on the main interface. If necessary, change the **MEASURE MODE** and **MEASURE POS** (measure position) in menu.

Take out the sensor from the sensor bracket. After warm-up, it beeps and displays **WARM-UP OVER** in information area.

Load a sensor cover by inserting the sensor into a sensor cover and press the sensor handle firmly. The sensor handle will move slightly to engage the sensor cover.

Holding the sensor handle with your thumb and two fingers, insert it to the measuring position.

For measuring oral TEMP, place the sensor tip under the patient's tongue on either side of the mouth to reach the rear sublingual pocket. Have the patient close his lips around the sensor.

Sublingual Pocket



Figure 10-1 Measuring Position in Mouth

For measuring oral TEMP, do not take an axillary temperature through patient's clothing.

The monitor enters **PREDICT** measuring mode, — — — displays in the TEMP parameter area. After Predict measuring is over, the measuring result displays, and **MEASURE OVER** appears on the interface.

If the predict measuring is successfully finished, the monitor enters **MONITOR** mode after 30s; otherwise the monitor enters **MONITOR** mode immediately after the predict measuring. The monitoring state lasts for 10 min, and then the monitor enters waiting state. — — — displays in the TEMP parameter area on interface. Put the sensor back into the sensor bracket.

If necessary, repeat the measurement according to the procedure above.

NOTE:

1. After one measurement, the user should put the sensor back to the sensor bracket and then take it out for starting a new measurement.
2. The reference body site temperature is the same as the temperature of the measuring site.

The monitor's state can change from the **PREDICT** mode into the **MONITOR** mode, but it cannot change from the **MONITOR** mode into the **PREDICT** mode.

10.1.3 TEMP Setup for T2 Module

Click on the **TEMP SETUP** in the **SYSTEM MENU** to set the following items:

- ◆ **MEASURE MODE:** Set the measuring mode to **PREDICT** or **MONITOR**.
- ◆ **MEASURE POS:** Set the measuring position to **ORAL**, **AXILLARY** or **RECTA**. The axillary sensor can be used for measuring oral/axillary temperature, while the rectal sensor for measuring rectal temperature.

10.1.4 Alarm

10.1.4.1 Adjustable Range of Alarm Limits

Patient Type	Measure position	ALM HI	ALM LO	Step
ADU	Oral/Axillary/Rectal	+42 °C (+107.6 °F)	+35.5 °C (+95.9 °F)	+0.1 °C
PED	Oral/Axillary/Rectal	+42 °C (+107.6 °F)	+35.5 °C (+95.9 °F)	+0.1 °C

11.1.4.2 Alarm Information and Prompts

WARNING

In monitoring mode, no physiological alarms are available.

Physiological alarms:

Message	Cause	Alarm Level
TEMP HIGH	Measuring value of TEMP is above upper alarm limit.	Medium
TEMP LOW	Measuring value of TEMP is below lower alarm limit.	Medium

Technical alarms:

Message	Cause	Alarm Level	What to do
Temp COMM STOP	TEMP module failure or communication failure.	High	Stop using measuring function of TEMP module; notify biomedical engineer or Manufacturer's service staff.
Temp limit exceed	The TEMP value is beyond the range of 35.5 °C ~ 42 °C	Medium	Put the sensor into the sensor bracket, take it out and measure again.
No TEMP SENSOR	TEMP sensor is not connected to the TEMP module.	Low	Connect the sensor and the monitor well, and measure again.
Ambient temp too high	The Sensor temperature is higher than +40 °C	Low	Put the sensor into the sensor bracket, measure again after the ambient temperature reaches normal value.
Ambient temp too low	The Sensor temperature is lower than +10 °C	Low	
PROBE ERROR	The probe cannot be identified.	Medium	Put the sensor into the sensor bracket, take it out and measure again. If the problem persists, stop using measuring function of TEMP module; notify biomedical engineer or Manufacturer's service staff.
Warm-up error	Malfunction in the warm-up circuit	Medium	

Prompt:

Message	Cause
Warm-up over	The monitor prompts it after taking the sensor out of the bracket and warm-up is over.
Measure over	After the Predict measuring is over, the data and message display on the interface.
Measure time out	No measuring result after the module entering Predict state for 30 s.
Probe temp too high	The original temperature of sensor $>+33\text{ }^{\circ}\text{C}$ and $\leq+40\text{ }^{\circ}\text{C}$.
Temp SENSOR OFF	The probe is disconnected from the patient.

10.2 TEMP Monitoring with TH Module

10.2.1 Introduction

M3 with the TH module (Infrared Ear Temperature Module) takes a temperature in the ear.

Diagram of the Infrared Ear Thermometer

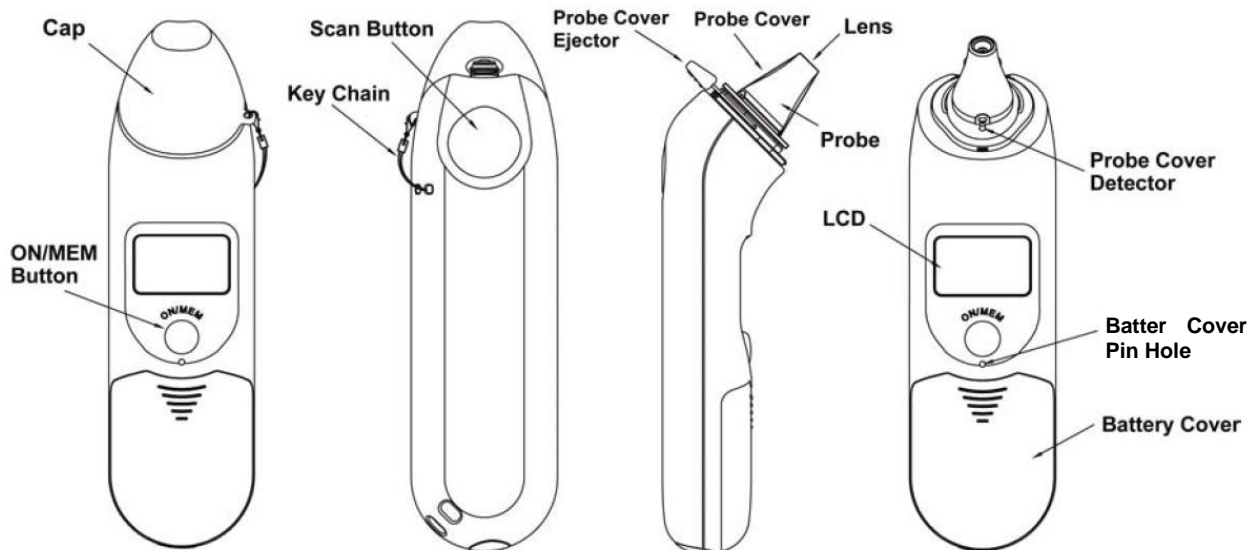

WARNING

- 1 The infrared ear thermometer is not intended for neonatal patients.
- 2 Only use the disposable probe covers supplied or recommended by EDAN. Use of other manufacturer's probe covers, reuse of disposable probe covers or absence of probe covers may produce temperature measurement errors and/or inaccuracies.

WARNING

- 3 Keep the probe covers away from children.
 - 4 Do not reuse the disposable probe covers.
-
-

CAUTION

- 1 Keep the probe window clean, dry, and undamaged at times to ensure accurate measurements. To protect the probe window, always keep the thermometer in the storage cover while transporting or when not in use.
 - 2 Proper installation of the probe cover ensures accurate measurements.
 - 3 Do not autoclave.
 - 4 The probe should not be submerged into liquids.
 - 5 Keep the unit dry and away from any liquids and direct sunlight.
 - 6 The thermometer is not waterproof. Do not immerse or drip fluids on it. Should this occur, dry the thermometer with warm air. Check for proper operation and accuracy.
 - 7 Holding the thermometer too long may cause a higher ambient temperature reading of the probe, which could make the body temperature measurements lower than usual.
 - 8 For more details about using the infrared ear thermometer, refer to the accompanying operating instructions of the thermometer.
 - 9 Check whether the thermometer is damaged once it drops. If you cannot make sure of it, send the complete device to your local dealer for recalibration.
 - 10 The monitor outfitted with the TH module must not be used together with other electrosurgery equipment, for example, ESU.
 - 11 Verification of the temperature module is necessary as frequently as dictated by your Hospital Procedures Policy. When you need to calibrate the temperature measurement, please contact the manufacturer.
 - 12 This thermometer converts the ear temperature to display its 'oral equivalent' (according to the result of the clinical evaluation to get the offset value). The thermometer is adjusted to display an oral temperature equivalent. Oral Mode = Ear Mode + 0.30 ° C.
 - 13 Remove the batteries from TH module if TH module is not used for a long period of time.
-
-

10.2.2 Measuring Procedure

1. Align the center of the probe to the center of the probe cover. Make sure to place the adhesive side of probe cover upward.

2. Insert the probe into the probe cover on the probe cover loader until the probe cover clicks in place.

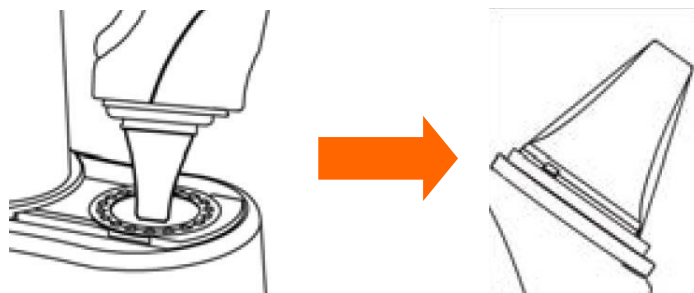
**NOTE:**

If the probe cover did not install well, the icon  will flash on the LCD of the thermometer, and you cannot take the ear temperature (with four beep sounds heard and without reading on the LCD when measuring).

3. Press ON/MEM button of the thermometer. The icon  will display on the LCD of the thermometer and you will hear two beep sounds.
4. Gently pull the ear back to straighten the ear canal and snugly fit the probe into the ear canal, aiming towards the membrane of the eardrum to obtain an accurate reading.

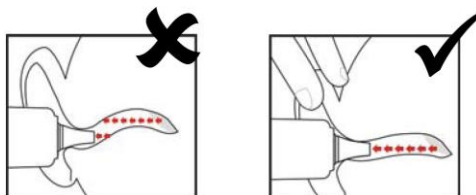
**NOTE:**

For children over two-year old and adults: pull the ear straight up and back as shown below:



5. Press the “Scan” button for one second until you hear a long beep sound which signals the end of the measurement, and results will be shown on the display of the monitor.
6. Before starting another measurement, wait until all icons stop flashing and two beep sounds are heard.

WARNING

Replace the probe cover after each use to ensure an accurate reading and avoid cross contamination.

NOTE:

- 1 The thermometer will automatically shut down after one-minute pending to extend battery life.

- 2 The device must stay in stable ambient (room) temperature for 30 minutes before operation.
- 3 Before the measurement, please stay in a stable environment for five minutes and avoid exercise or bath for 30 minutes.
- 4 It is recommended that you measure the same ear for three times. If the three measurements are different, select the highest temperature.
- 5 Remember to compare the measurement result to the regular temperature of the patient.
- 6 There is no gender and age limitation for using infrared ear thermometer.
- 7 The data saved in the thermometer is the last measurement data before the thermometer is powered off.
- 8 Clinical repeatability: 0.12 °C (1~5 years old); 0.10 °C (> 5 years old).

10.2.3 Alarm

10.2.3.1 Adjustable Range of Alarm Limits

Patient Type	Measure position	ALM HI	ALM LO	Step
ADU/PED/NEO	Ear	+42 °C (+107.6°F)	+35.5 °C (+95.9 °F)	+0.1 °C

10.2.3.2 Alarm Information and Prompts

Physiological alarms:

Message	Cause	Alarm Level
TEMP HIGH	Measuring value of TEMP is above upper alarm limit.	Medium
TEMP LOW	Measuring value of TEMP is below lower alarm limit.	Medium

Technical alarms:

Message	Cause	Alarm Level	What to do
Temp limit exceed	The TEMP value is beyond the range of 34 °C --42.2 °C.	Medium	Check the integrity of the probe cover, make sure it is clean, and take a new measurement.

The infrared ear thermometer will also give error messages on its screen. For details about the error messages, refer to the accompanying operating instructions of the thermometer.

NOTE:

If the infrared ear thermometer frequently signals ERR alarms, the insulated board inside the thermometer housing is malfunctioning or the ambient temperature changes, and the monitor will delete the measurement values onscreen to avoid misoperation.

10.2.4 Replacing the Battery

The device is supplied with one lithium cell CR2032x1.

To replacing the battery, follow the procedure:

1. Open the battery cover by inserting a pointed object into the battery cover pin hole; meanwhile, use thumb to push battery cover out.



2. Hold the thermometer and flip the battery out with a small screwdriver.



3. Insert the new battery under the metal hook on the left side ① and press the right side ② of the battery down until the it clicks in place.

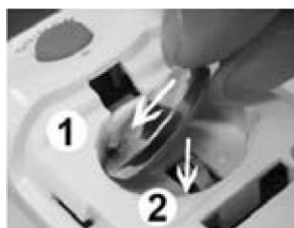

WARNING

- 1 Keep the battery away from children.
 - 2 Ensure the positive (+) side is up and the negative (-) side down.
-

10.3 TEMP Monitoring with F3000 Module

10.3.1 General Information

M3 with the F3000 module measures patient temperatures by oral, axillary or rectal means.

The monitor can only measure temperature of adult and pediatric patients. If the user measure temperature of neonate patient, the monitor will not display data.

The electromagnetic compatibility of this device has been verified by test according to the EN60601-1-2: 2015 requirements.

10.3.2 Safety Information

WARNING

- 1 Do not use this device near flammable anesthetics. Not suitable for use in the presence of flammable anesthetic mixture with air, oxygen or nitrous oxide.
 - 2 Do not use this thermometer without first installing a new probe cover.
 - 3 Use probe covers supplied by the manufacturer with this thermometer only. Use of any other probe cover will result in erroneous temperature readings.
 - 4 The thermometer and probe covers are Non-sterile. Do not use on abraded tissue.
 - 5 To limit cross contamination, use Blue devices for Oral and Axillary temperature taking only.
 - 6 Use RED devices only for RECTAL temperatures.
 - 7 Thoroughly dry all electrical contacts on both probe and thermometer after washing, or device may fail to function properly.
 - 8 For re-calibration, service or integrity checks, refer to a qualified Biomedical Technician or return to the manufacturer.
 - 9 Do not open the F3000 module. No user-serviceable parts inside. Opening of the module may affect calibration and voids warranty.
 - 10 Cleaning frequency and practices must be consistent with institutional policy for cleaning of non-sterile devices.
 - 11 The F3000 module is not intended for neonatal patients.
 - 12 Disposal of used probe covers must be performed in accordance with current medical practices or local regulations regarding disposal of infectious, biological medical waste.
 - 13 In monitoring mode, no physiological alarms are available.
-

NOTE:

1. Even though this device has been designed to minimize the effects of electromagnetic interference, it does generate radio frequency energy. If not used in accordance with the instructions, the device could cause interference in other equipment operating within its vicinity. If the device is causing interference, the following actions may be taken in an attempt to correct the interference:
 - Re-orient or re-locate the receiving device.
 - Increase the separation between the devices.
 - Consult a customer service representative.
2. Verification of the temperature module is necessary as frequently as dictated by your Hospital Procedures Policy. When you need to calibrate the temperature

measurement, please contact the manufacturer.

3. The reference body site temperature is the same as the temperature of the measuring site.

10.3.3 Probe Covers —Applying & Removing

1. Open probe cover box by lifting tab at top corner and pulling to remove top panel.
2. Insert box of probe covers into top of isolation chamber.

NOTE:

To aid infection control, never switch boxes between blue and red isolation chambers. Also, never switch probes between blue and red isolation chambers. Keep like colors together.

3. Remove probe from the probe well. This automatically turns on the thermometer.
4. To help remind the user to apply or remove a probe cover, a probe icon with flashing probe cover will be displayed when the probe is withdrawn from the probe well and following a completed temperature measurement.
5. Insert the probe end into a cover in the box. Push the handle firmly until you feel the cover “snap” into place.
6. Take appropriate temperature measurement (oral, axillary or rectal).
7. Eject the used cover into bio-waste container by pressing top button.
8. Remove, discard and replace box when empty.

10.3.4 Changing Isolation Chambers and Probes

NOTE:

1. For aiding in infection control, use only the Blue probe and Blue isolation chamber for Oral and Axillary temperature taking. The Red probe and Red isolation chamber must only be used for rectal temperature taking.
2. Do not attach a Red probe to a Blue isolation chamber or vice-versa.
1. To remove or replace any isolation chamber/probe assembly, grasp the isolation chamber from each side as shown.
2. Squeeze inward releasing the snaps and slide the isolation chamber up to pull off.
3. To replace, align probe well finger with opening in the top of the unit.
4. Slide the isolation chamber down until the side snaps “click” into place.
5. The probe is connected to the thermometer automatically.
6. To change probes, remove the isolation chamber as described previously.
7. Grasp the sides of the L-shaped connector piece with one hand and then using other hand pull backward on the latch holding the end of the L-shaped connector.

8. Once free of the latch, slide the L-shaped connector out of isolation chamber.
9. To replace, properly align the top of the L-shaped connector to the slot on the back of the isolation chamber.
10. Then slide the connector up into the slot pressing firmly on the bottom of the connector until it “clicks” into place.

10.3.5 Measuring Mode

Predictive Mode

When **MEASURE MODE** is set to **PREDICT**, the monitor operates in Predictive Mode to provide fast and accurate temperature measurements.

Quick Predictive Mode

When **MEASURE MODE** is set to **QUICK PREDICT**, the monitor operates in Quick Predictive Mode which is an oral predictive measurement mode intended for situations where fast temperature measurements are desired.

Quick Predictive Mode allows clinicians to rapidly identify patients with “normal” body temperatures. If the patient temperature is outside of the “normal” range, the monitor will automatically switch into its standard predictive mode to provide a more accurate reading.

Quick Predictive Mode is not available when in Cold Mode.

Monitoring Mode

When **MEASURE MODE** is set to **MONITOR**, the monitor will perform continual temperature measurement for a maximum of 10 minutes.

Besides, in the following instances, the monitor will automatically switch to Monitoring Mode and perform temperature measurement for a maximum of 5 minutes until the temperature stabilizes:

1. When the monitor operates in Predictive Mode, no measurement site is detected or the temperature does not stabilize.
2. When the monitor operates in Predictive Mode or Quick Predictive Mode, the ambient temperature is greater than 35 °C (95 °F).

Cold Mode

Cold Mode is provided for use in applications where body temperatures may be lower than “normal”, such as for patients recently out of surgery.

The accuracy and measurement time of Cold Mode measurements are equivalent to standard prediction measurements at the respective body sites.

10.3.6 Measuring Procedure

Oral and Axillary Temperature Taking

1. Make certain that the Blue isolation chamber /probe unit is attached.

2. Withdraw probe and apply a probe cover. The thermometer turns on automatically and a beep will be heard when the probe completes warm-up.
3. For Oral temperatures, insert the probe tip deep into the sublingual pocket next to the frenulum linguae, (vertical fold of tissue in middle of tongue), on one side or the other, toward the back of the mouth.

NOTE:

Accurate body temperature readings can only be obtained in one of these two “heat pocket” locations as shown. Temperatures taken in other mouth locations will result in inaccurate body temperature readings.

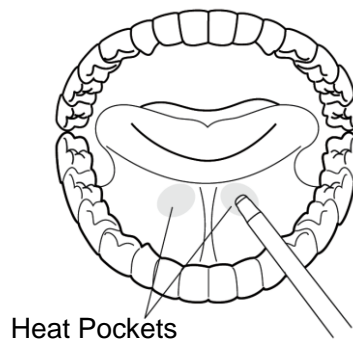

4. Patient's mouth must be CLOSED.
5. Securely hold the probe in place until the temperature is displayed.
6. For Axillary temperatures, have the patient raise the arm, then place the probe tip in the axilla. Press gently to assure good contact. For the most accurate temperature the probe tip should be placed directly against the patient's skin.
7. Have the patient then lower the arm and remain as still as possible. Hold the probe parallel to the arm as shown.

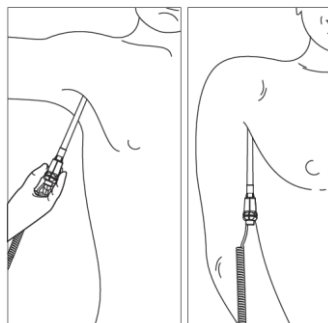

8. If three short beeps are heard, it means the unit switched to Monitoring Mode for this temperature only.
9. Two beeps are sounded when measurement is complete and the final temperature is displayed.
10. Eject the used cover into a bio-waste container by pushing top button.

Rectal Temperature Taking

1. Make certain that the Red isolation chamber/probe unit is attached.

2. Withdraw the probe and apply a probe cover. Thermometer turns on automatically a beep will be heard when the probe completes warm-up.
3. Apply lubrication if desired.
4. Insert the probe into the patient's rectum. To ensure proper tissue contact, angle the probe slightly after insertion.*
5. Depth of insertion is recommended at 1/2" to 3/4" (12 mm ~ 19 mm) for adults and 1/4" to 1/2" (6 mm ~ 13 mm) for children.
6. If three short beeps are heard, it means the unit switched to Monitoring Mode for this temperature only.
7. Two beeps are sounded when measurement is complete and the final temperature is displayed.
8. Eject the used cover into a bio-waste container by pushing top button.

NOTE:

- 1 Probe movement during a measurement can affect the thermometer's ability to measure the site temperature and may lengthen the time required to obtain a reading.
- 2 If a beep is not heard 10 seconds after withdrawing the probe from the probe well and starting temperature measurement in Predictive Mode or Quick Predictive Mode, check the physical connection of the F3000 module.

10.3.7 TEMP Setup for F3000 Module

Click **TEMP SETUP** in the **SYSTEM MENU**, and the following settings are available:

MEASURE MODE: Set the measuring mode to **PREDICT**, **QUICK PREDICT** or **MONITOR**.

MEASURE POS: Set the measuring position to **ORAL**, **AXILLARY** or **RECTA**.

COLD MODE: Activate /deactivate the cold mode by setting it to **ON** /**OFF**.

NOTE:

- 1 The **QUICK PREDICT** mode is for oral measurement only.
- 2 The **QUICK PREDICT** mode is unavailable when **COLD MODE** is set to **ON**.
- 3 Make sure all settings of TEMP Setup are properly set up every time before you withdraw the probe from the probe well. If you modify the settings immediately a measurement is completed, the new settings will be effective for the next measurement.

10.3.8 Alarm

10.3.8.1 Adjustable Range of Alarm Limits

Patient Type	Measure position	ALM HI	ALM LO	Step
ADU/PED	Oral/Axillary/Rectal	+43 °C (39 °C by default)	+33 °C (36 °C by default)	0.1 °C

10.3.8.2 Alarm Information and Prompts

WARNING

In monitoring mode, no physiological alarms are available.

Physiological alarms:

Message	Cause	Alarm Level
TEMP HIGH	Measuring value of TEMP is above the upper alarm limit.	Medium
TEMP LOW	Measuring value of TEMP is below the lower alarm limit.	Medium

Technical alarms:

Message	Cause	Alarm Level	What to do
Temp Error E01	System error during synchronization.	Medium	Stop using measuring function of TEMP module; notify biomedical engineer or Manufacturer's service staff.
Temp Error E02	System error during patient thermistor calibration.	Medium	
Temp Error E03	System error during heater thermistor calibration.	Medium	
Temp Error E04	System timing error.	Medium	
Heater error	Heater error.	Medium	
Temp COMM STOP	TEMP module failure or communication failure.	High	Stop using measuring function of TEMP module; notify biomedical engineer or Manufacturer's service staff.
Temp Error P02	Monitor mode patient thermistor unstable or out of range.	Low	

Message	Cause	Alarm Level	What to do
Temp Error P03	Monitor mode heater thermistor unstable or out of range.	Low	
Temp Error P04	Predict Mode patient thermistor unstable or out of range.	Low	
Temp Error P05	Predict Mode heater thermistor unstable or out of range.	Low	
Temp exceed limit	The TEMP value is out of the range of +30 °C ~ +43 °C.	Medium	Put the probe into the probe well; take it out and measure again.
No TEMP SENSOR	Probe configuration (or no probe connected) error.	Low	Well connect the probe and the monitor, and measure again.
Temp Error P06	Unable to pre-heat probe tip.	Low	Stop using measuring function of TEMP module; notify biomedical engineer or Manufacturer's service staff. NOTE: Measure readings displayed on the screen are unreliable when the monitor indicates Temp Error P06.
Measure Site Error	The probe in use is not consistent with the measure position set on the monitor.	Medium	Correctly set the measure position on the monitor.

Prompts:

Message	Cause
Warm-up over	The monitor prompts it after the probe is taken out of the probe well and warm-up is over.
Measure over	Prediction measurement is completed.
Quick Predict Over	Quick prediction measurement is completed.
MONITORING	The mode is switching to Monitor Mode.

Chapter 11 Other Functions

11.1 Nurse Call

The monitor provides dedicated nurse call port which is connected to nurse call system through the nurse call cable to perform the nurse call function.

NOTE:

Before using the function of nurse call, check if it is functioning normally.

11.2 Network

The monitor can be connected with PC through network port. Also, the monitor can construct wireless network with router. Our company arranges the qualified engineers to install and set the wired or wireless network for the user and test the corresponding performance. For details, please refer to *Patient Monitor Wireless Network Installation Guide*.

NOTE:

- 1 Be aware that some network-based functions may be limited for monitors on wireless networks in comparison with those on wired networks.
- 2 The obstacle may interfere with data transmission and even cause data loss.
- 3 Use the wireless device recommended by EDAN, otherwise some exceptional situations such as frequent network disconnection may occur on the monitor.
- 4 When signal intensity is unstable, the quality of the signal transmission may be degraded.
- 5 For detailed specifications of router, please refer to the router's user guide.
- 6 When the monitor is connected to MFM-CMS via the wireless network, the user should set the router to a secure encryption/authentication mode (Recommended option: WPA2-PSK, with a high complexity, non-dictionary password).

11.3 Central Monitoring System

The monitor can be connected to the central monitoring system. Through the network:

1. The monitor sends patient information, real-time monitoring or measurement data to the central monitoring system.
2. The real-time monitoring information is displayed on the central monitoring system as the same to the monitor, and the central monitoring system can perform some bilateral control. For example: changing patient information, receiving patient, discharging patient and so on.
3. The alarm information of bed side monitor is displayed on the central monitoring system For example: audio alarm paused, audio alarm off and physiological alarm status and so on.

For detailed information, please refer to *MFM-CMS Central Monitoring System User Manual*.

NOTE:

- 1 MFM-CMS can display max 12 bits barcode.
- 2 Make sure the **Free Online Mode** in CMS is turned on when the barcode is more than 12 bits, and then the monitor can display the real barcode.
- 3 When deploying the network of the monitor and MFM-CMS, it is recommended to isolate the network and the Intranet system of the hospital by using VLAN so as to ensure the network security.

Chapter 12 Accessories

You can order accessories from EDAN supplies at www.edan.com.cn or consult your local Edan representative for details.

WARNING

- 1 Never reuse disposable transducers, sensors, accessories and their casing that are intended for single use; or only use them on a single patient. Reuse may compromise device functionality and system performance and cause a potential hazard.
- 2 Use only EDAN-approved accessories. Using non-EDAN-approved accessories may compromise device functionality and system performance and cause a potential hazard. It is not recommended to use accessories supplied by EDAN with patient monitors by other manufacturers.
- 3 Do not use a sterilized accessory if its casing is damaged.

NOTE:

Transducers and sensors have a limited shelf life. Refer to the package labeling.

The following cables may not all be available in all countries. Please check availability with your local EDAN supplier.

The following accessories are recommended when using this monitor.

EDAN SpO₂	
02.01.210119	SH1 Adult Reusable SpO ₂ Sensor (Lemo)
02.01.210120	SH1 Adult Reusable SpO ₂ Sensor (DB9)
02.01.110492	SpO ₂ Warp Sensor, Neonate, 1m, reusable
02.01.210122	SH4 Adult Silicone Soft-tip SpO ₂ Sensor
02.01.210121	SH5 pediatric Silicone Soft-tip SpO ₂ Sensor
01.13.210001	SpO ₂ adapter cable, standard (Lemo to DB9)
01.57.471238	SHD-N SpO ₂ Sensor, Neonate, disposable
01.57.471237	SHD-I SpO ₂ Sensor, Infant, disposable
01.57.471236	SHD-P SpO ₂ Sensor, pediatric, disposable
01.57.471235	SHD-A SpO ₂ Sensor, adult, disposable

NELLCOR SpO₂	
01.15.30043	Nellcor Reusable Adult SpO ₂ Sensor (DS-100A OxiMax)
01.15.40096	Nellcor Reusable Adult/Neonate SpO ₂ Sensor (OXI-A/N OxiMax)
NIBP	
01.57.471326	NIBP Cuff, E5, Infant, 10-15 cm, reusable
01.57.471327	NIBP Cuff, E6, Small child, 13-17 cm, reusable
01.57.471328	NIBP Cuff, E7, Child, 16-21.5 cm, reusable
01.57.471329	NIBP Cuff, E8, Small adult, 20.5-28 cm, reusable
01.57.471330	NIBP Cuff, E9, Adult, 27-35 cm, reusable
01.57.471331	NIBP Cuff, E10, Large adult, 34-43 cm, reusable
01.59.036118	NIBP Tube, 3 m
01.57.471442	NIBP Cuff, E7, Child, reusable
01.57.471443	NIBP Cuff, E8, Small adult, reusable
01.57.471444	NIBP Cuff, E9, Adult, reusable
01.57.471005	NIBP Hose, Quick Connect to Quick Connect
01.57.471291	NIBP Tube, 3 m
01.57.471303	NIBP Tube, 3 m
01.57.471021	NIBP Tube for neonatal cuff, 3 m
TEMP (For T2 Module)	
02.04.110140	Oral/Axillary Probe
02.04.110139	Rectal Probe
01.57.110159	Probe Covers, WelchAllyn REF #05031

TEMP (For TH Module)	
01.13.036415	Infrared Ear Thermometer Communication Cable
01.57.208057	Infrared Ear Thermometer
01.57.208058	Probe Cover
01.57.208059	Probe Cover Loader
TEMP (For F3000 Module)	
01.57.471312	Filac 3000 Oral Probe 4ft
01.57.471313	Filac 3000 Oral Probe 9ft
01.22.066159	Filac 3000 Oral Isolation Chamber
01.57.471314	Filac 3000 Rectal Probe 4ft
01.57.471315	Filac 3000 Rectal Probe 9ft
01.22.066160	Filac 3000 Rectal Isolation Chamber
01.57.471316	Filac 3000 Probe Covers
Others	
01.57.78035	Printing Paper
01.13.36014	Power Cable (IEC Standard), 1.8 m
01.13.036106	Power cord (USA),1.8 m
01.21.064142	Rechargeable Lithium-Ion Battery/ TWSLB-002 (14.8 V, 2500 mAh)
01.21.064143	Rechargeable Lithium-Ion Battery/ TWSLB-003 (14.8 V, 5000 mAh)
01.13.036667	Power cord (3C), 3 m
01.13.114114	Ground Cable
01.23.068003	USB barcode scanner (Cipher LAB 1000U, USB port, contact, CCD scan)
01.56.466104	M3 series portable bag

02.04.241690	Patient monitor mounting arm assembly kit (Big basket)
83.60.261116	MT-206 Trolley (Plastic wheels)
83.60.261069	MT-206 Trolley (Metal wheels)
02.04.101976	Rolling Stand Basket (in the bottom)
02.04.243472	Patient monitor mounting arm assembly kit (Small basket)

NOTE:

The part name may vary depending on context, but the part number is constant.

Chapter 13 Warranty and Service

13.1 Warranty

EDAN warrants that EDAN's products meet the labeled specifications of the products and will be free from defects in materials and workmanship that occur within warranty period.

The warranty is void in cases of:

- a) Damage caused by mishandling during shipping.
- b) Subsequent damage caused by improper use or maintenance.
- c) Damage caused by alteration or repair by anyone not authorized by EDAN.
- d) Damage caused by accidents.
- e) Replacement or removal of serial number label and manufacture label.

If a product covered by this warranty is determined to be defective because of defective materials, components, or workmanship, and the warranty claim is made within the warranty period, EDAN will, at its discretion, repair or replace the defective part(s) free of charge. EDAN will not provide a substitute product for use when the defective product is being repaired.

13.2 Contact Information

If you have any question about maintenance, technical specifications or malfunctions of devices, contact your local distributor.

Alternatively, you can send an email to EDAN service department at: support@edan.com.cn

Appendix A Specifications

A.1 Classification

Anti-electroshock type	Class I equipment and internal powered equipment
Anti-electroshock degree	SpO ₂ , NIBP: BF TEMP: CF (T2 module) BF (TH module, F3000 module)
Ingress protection	IPX1 With T2, TH or F3000 TEMP module: Ordinary equipment (Sealed equipment without liquid proof)
Working system	Continuous operation equipment
Compliant with standards	IEC 60601-1: 2005+A1:2012; IEC 60601-1-2:2014; EN 60601-1: 2006+A1: 2013; EN 60601-1-2: 2015; IEC 80601-2-30: 2009+A1: 2013; ISO 80601-2-61: 2011; ISO 80601-2-56: 2009; IEC 60601-2-49:2011

A.2 Specifications

NOTE:

The performance of the equipment with ☆ mark is determined to be essential performance.

A.2.1 Size and Weight

Size	(174±2) mm (W) × (235±2) mm (H) × (189±2) mm (D)
Weight	≤3.5 kg (not including battery)

A.2.2 Function Configuration

Model	Standard Function	Optional Function
M3	SpO ₂ , NIBP	TEMP

A.2.3 Environment

The monitor may not meet the performance specifications given here if stored or used outside the specified temperature and humidity ranges.

When the monitor and related products have differing environmental specifications, the effective range for the combined products is that range which is common to the specifications for all products.

Temperature	
Working	0 °C ~ +40 °C (32 °F ~104 °F)
	With TEMP: +10 °C ~ +40 °C (50 °F ~104 °F)
Transport and storage	-20 °C ~ +55 °C (-4 °F ~131 °F)
	With TH module: -20 °C ~ +50 °C (-4 °F ~122 °F)
Humidity	
Working	15% RH ~ 95% RH (non-condensing)
Transport and storage	15% RH ~ 95% RH (non-condensing)
Altitude	
Working	86 kPa ~ 106 kPa
Transport and storage	70 kPa ~ 106 kPa
Power supply	Voltage: 100 V–240 V ~
	Frequency: 50 Hz/60 Hz
	Pmax: 70 VA, FUSE: T2.0 AH250 VP

A.2.4 Display

Device	5.6-inch color TFT. Resolution: 640×480
Messages	1 Power Supply Indicator LED (Green)
	1 Power On Indicator LED (Green)
	1 Alarm Indicator LED (Red/Yellow)
	1 Charge Indicator LED (Yellow)
	1 Alarm Mute Indicator LED (Backlight)
	1 NIBP Working Status Indicator LED (Backlight)
	3 indicating modes correspond to Alarm Mode

A.2.5 Battery

Quantity	1
Type	Li-ion battery
Capacitance	2500 mAh/5000 mAh

Working period (With a new fully charged battery, at (25 ± 2) °C, continuous SpO ₂ measuring, NIBP automatic measuring mode with the operating interval of 15 minutes, automatic recording per 10 minutes)	
Typical Working Period	2500 mAh: 7 h; 5000 mAh: 14 h
Maximum Rechargeable Period	2500 mAh: 3.5 h; 5000 mAh: 7 h
	(The monitor is on or in standby mode.)

A.2.6 Recorder

Record width	48 mm
Paper speed	12.5 mm/s, 25 mm/s
Recording types	Parameter list recording
	Trend graph review recording
	Alarm list recording
	Real-time 8s waveform recording
	Recording of all the data of current patient ID
	Real-time alarm recording

A.2.7 Data Storage

Trend	72 h, at 1 min resolution
NIBP trend list	30, 000 groups
Alarm list	800 groups

A.2.8 NIBP

Mode	Manual, Auto, Continuous
Measuring interval in AUTO mode (unit: minute)	1/2/3/4/5/10/15/30/60/90/120/240/480
Measure time in continuous measure mode	5 min, interval is 5 s
Measuring type	Systolic Pressure, Diastolic Pressure, Mean Pressure, Pulse Rate
☆Measuring range	
ADU mode	SYS 40 mmHg ~270 mmHg

	DIA 10 mmHg ~ 215 mmHg
	MAP 20 mmHg ~235 mmHg
PED mode	SYS 40 mmHg ~230 mmHg
	DIA 10 mmHg ~180 mmHg
	MAP 20 mmHg ~195 mmHg
NEO mode	SYS 40 mmHg ~ 135 mmHg
	DIA 10 mmHg ~100 mmHg
	MAP 20 mmHg ~110 mmHg
☆ Alarm type	SYS, DIA, MAP, PR
☆ Cuff Pressure measuring range	0 mmHg ~300 mmHg
☆ Pressure resolution	1 mmHg
☆ Maximum mean error	± 5 mmHg
☆ Maximum standard deviation	8 mmHg
Maximum measuring time of single measurement	ADU/PED 120 s NEO 90 s
Typical measuring period	20 s ~ 35 s (depend on HR/motion disturbance)
Overpressure protection	
ADU	(297 ±3) mmHg
PED	(245 ±3) mmHg
NEO	(147 ±3) mmHg
PR	
☆ Measuring range	40 bpm ~240 bpm
☆ Accuracy	±3 bpm or 3.5%, whichever is greater

A.2.9 SpO₂

EDAN Module	
☆ Measuring Range	0% ~100%
☆ Adjustable range of alarm limits	0% ~100%
Resolution	1%

☆Data update period	1 s	
☆Accuracy		
Adult /Pediatric	±2% (70%~100% SpO ₂)	
	Undefined (0~69% SpO ₂)	
Neonate	±3% (70%~100% SpO ₂)	
	Undefined (0~69% SpO ₂)	
PI		
Measuring Range	0-10. It displays 0 for invalid PI value.	
Resolution	1	
Sensor		
Red light	(660±3) nm	
Infrared light	(905±10) nm	
Emitted light energy	< 15 mW	
Nellcor Module (optional)		
☆Measuring Range	1% ~100%	
☆Adjustable range of alarm limits	0% ~100%	
Resolution	1%	
☆Data update period	1s	
☆Accuracy	DS-100A, OXI-A/N (Adult):	±3% (70% ~100% SpO ₂)
	OXI-A/N (Neonate):	±4% (70% ~100% SpO ₂)
Sensor	Wave length: approximately 660 nm and 900 nm	
	Emitted light energy: <15 mW	

NOTE:

The information about wavelength range can be especially useful to clinicians (for instance, when photodynamic therapy is performed).

A.2.10 PR

		Measuring range	Accuracy	Resolution
PR (SpO ₂)	EDAN	25 bpm to 300 bpm	±2 bpm	1 bpm
	Nellcor	20 bpm to 300 bpm	± 3 bpm (20 bpm to 250 bpm)	1 bpm
PR (NIBP)	EDAN	40 bpm to 240 bpm	±3 bpm or 3.5%, whichever is greater	1 bpm

A.2.11 TEMP**T2 Module:**

☆Measuring range	Monitor mode: 25 °C~45 °C Predict mode: 35.5 °C~42 °C
Working temperature	10 °C ~40 °C
Sensor type	Oral /axillary /rectal
☆Adjustable range of alarm limits	35.5 °C ~42 °C
Resolution	0.1 °C
☆Accuracy	Monitor mode: ±0.1 °C (25 °C~ 45 °C)
Response time	< 60 s
Update time	1 s~ 2 s
Warm-up time	<10 s
Time for predicting	<30 s
Calibration	Self-test interval: ≤5 min
Measuring Mode	Direct Mode/ Adjusted Mode
Transient Response Time	≤30 s
Clinical Bias	(-0.2 to -0.4)°C
Limits of Agreement	0.49
Stability	0.14 °C

NOTE:

The direct mode refers to monitor mode, while adjusted mode refers to predict mode.

TH Module:

☆Measuring range	34 °C~ 42.2 °C
Working temperature	10 °C~ 40 °C
☆Adjustable range of alarm limits	35.5 °C~ 42 °C
Resolution	0.1 °C
Response time	1 s
Measuring Mode	Adjusted Mode
Clinical Accuracy	±0.2 °C (0.4 ° F) (35.5 °C ~42 °C) (95 ° F ~107.6° F) ±0.3 °C (0.5 ° F) (out of the range mentioned above)
Laboratory Accuracy	±0.2 °C

F3000 Module:

☆Measuring range	30 °C~43 °C
Prediction measurement range	35 °C~43 °C
Cold mode prediction measurement range	33 °C~43 °C
Working temperature	10 °C ~ 40 °C
Sensor type	Oral /axillary /rectal
☆Adjustable range of alarm limits	33 °C~43 °C
Resolution	0.1 °C
☆Accuracy	Monitoring Mode and Predictive Mode: ±0.1 °C Quick Predictive Mode: ±0.3 °C
Typical measurement time (after insertion into measurement site)	Oral (Quick Predictive Mode): (3~5) s (non-fever temps); (8~10) s (fever temps)
	Oral (Predictive Mode): (6~10) s
	Axillary: (8~12) s
	Rectal: (10~14) s
	Monitoring Mode (all sites): (60~120) s

Measuring Mode	Direct Mode /Adjusted Mode
Transient Response Time	≤ 30 s
Clinical Bias	(-0.2 to -0.4)°C
Limits of Agreement	0.49
Stability	0.14 °C

NOTE:

The direct mode refers to monitor mode, while adjusted mode refers to predictive mode and quick predictive mode.

Appendix B EMC Information - Guidance and Manufacturer's Declaration

B.1 Electromagnetic Emissions

Guidance and manufacture's declaration – electromagnetic emission		
M3 is intended for use in the electromagnetic environment specified below. The customer or the user of M3 should assure that they are used in such an environment.		
Emission test	Compliance	Electromagnetic environment – guidance
RF emissions CISPR 11	Group 1	M3 uses RF energy only for their internal function. Therefore, their RF emissions are very low and are not likely to cause any interference in nearby electronic equipment.
RF emission CISPR 11	Class A	M3 is suitable for use in all establishments, other than domestic establishments and those directly connected to the public low-voltage power supply network that supplies buildings used for domestic purposes.
Harmonic emissions IEC/EN 61000-3-2	Class A	
Voltage fluctuations/ flicker emissions IEC/EN 61000-3-3	Complies	

NOTE:

The EMISSIONS characteristics of M3 make it suitable for use in industrial areas and hospitals (CISPR 11 class A). If it is used in a residential environment (for which CISPR 11 class B is normally required) M3 might not offer adequate protection to radio-frequency communication services. The user might need to take mitigation measures, such as relocating or re-orienting the equipment.

B.2 Electromagnetic Immunity

Guidance and manufacture's declaration – electromagnetic immunity			
M3 is intended for use in the electromagnetic environment specified below. The customer or the user of M3 should assure that they are used in such an environment.			
Immunity test	IEC/EN 60601 test level	Compliance level	Electromagnetic environment - guidance

Electrostatic discharge (ESD) IEC/EN 61000-4-2	± 8 kV contact ± 15 kV air	± 8 kV contact ± 15 kV air	Floors should be wood, concrete or ceramic tile. If floor are covered with synthetic material, the relative humidity should be at least 30%.
Electrical fast transient/burst IEC/EN 61000-4-4	± 2 kV for power supply lines	± 2 kV for power supply lines	Mains power quality should be that of a typical commercial or hospital environment.
Surge IEC/EN 61000-4-5	± 1 kV for line to line ± 2 kV for line to ground	± 1 kV for line to line ± 2 kV for line to ground	Mains power quality should be that of a typical commercial or hospital environment.
Power frequency (50/60Hz) magnetic field IEC/EN 61000-4-8	30 A/m	30 A/m	Power frequency magnetic fields should be at levels characteristic of a typical location in a typical commercial or hospital environment.
Voltage dips, short interruptions and voltage variations on power supply input lines IEC/EN 61000-4-11	0 % UT; 0.5 cycle At 0 °, 45 °, 90 °, 135 °, 180 °, 225 °, 270 ° and 315 ° 0 % UT; 1 cycle and 70 % UT; 25/30 cycles) Single phase: at 0 ° 0 % UT; 250/300 cycle	0 % U _T ; 0.5 cycle At 0 °, 45 °, 90 °, 135 °, 180 °, 225 °, 270 ° and 315 ° 0 % U _T ; 1 cycle and 70 % U _T ; 25/30 cycles) Single phase: at 0 ° 0 % U _T ; 250/300 cycle	Mains power quality should be that of a typical commercial or hospital environment. If the user of M3 requires continued operation during power mains interruptions, it is recommended that M3 be powered from an uninterruptible power supply or a battery.
NOTE U _T is the a.c. mains voltage prior to application of the test level.			

B.3 Electromagnetic Immunity

Guidance and manufacture's declaration – electromagnetic immunity			
M3 is intended for use in the electromagnetic environment specified below. The customer or the user of M3 should assure that they are used in such an environment.			
Immunity test	IEC/EN 60601 test level	Compliance level	Electromagnetic environment - guidance
<p>Conducted RF IEC/EN 61000-4-6</p> <p>Radiated RF IEC/EN 61000-4-3</p>	<p>3 V_{rms} 150 kHz to 80 MHz 6V_{rms}^c in ISM bands between 0.15 MHz and 80 MHz</p> <p>3 V/m 80 MHz to 2.7 GHz</p> <p>See table 1</p>	<p>3 V_{rms} 150 kHz to 80 MHz 6V_{rms}^c in ISM bands between 0.15 MHz and 80 MHz</p> <p>3 V/m 80 MHz to 2.7 GHz</p> <p>Comply with table 1</p>	<p>Portable and mobile RF communications equipment should be used no closer to any part of M3, including cables, than the recommended separation distance calculated from the equation applicable to the frequency of the transmitter.</p> <p>Recommended separation distance</p> <p>$d = 1.2\sqrt{P}$ 150KHz to 80MHz</p> <p>$d = 1.2\sqrt{P}$ 80 MHz to 800 MHz</p> <p>$d = 2.3\sqrt{P}$ 800 MHz to 2.7 GHz</p> <p>$d = 6\sqrt{P}/E$ /E at RF wireless communications equipment bands (Portable RF communications equipment (including peripherals such as antenna cables and external antennas) should be used no closer than 30 cm (12 inches) to any part of the M3, including cables specified by the manufacturer).</p> <p>Where P is the maximum output power rating of the transmitter in watts (W) according to the transmitter manufacturer and d is the recommended separation distance in meters (m).</p> <p>Field strengths from fixed RF</p>

			<p>transmitters, as determined by an electromagnetic site survey,^a should be less than the compliance level in each frequency range.^b</p> <p>Interference may occur in the vicinity of equipment marked with the following symbol:</p> 
<p>NOTE 1 At 80 MHz and 800 MHz, the higher frequency range applies.</p>			<p>NOTE 2 These guidelines may not apply in all situations. Electromagnetic propagation is affected by absorption and reflection from structures, objects and people.</p>
<p>^a Field strengths from fixed transmitters, such as base stations for radio (cellular/cordless) telephones and land mobile radios, amateur radio, AM and FM radio broadcast and TV broadcast cannot be predicted theoretically with accuracy. To assess the electromagnetic environment due to fixed RF transmitters, an electromagnetic site survey should be considered. If the measured field strength in the location in which M3 is used exceeds the applicable RF compliance level above, M3 should be observed to verify normal operation. If abnormal performance is observed, additional measures may be necessary, such as reorienting or relocating M3.</p> <p>^b Over the frequency range 150kHz to 80MHz, field strengths should be less than 3V/m.</p> <p>^c The ISM (industrial, scientific and medical) bands between 0.15 MHz and 80 MHz are 6.765 MHz to 6.795 MHz; 13.553 MHz to 13.567 MHz; 26.957 MHz to 27.283 MHz; and 40.66 MHz to 40.70 MHz. The amateur radio bands between 0.15 MHz and 80 MHz are 1.8 MHz to 2.0 MHz, 3.5 MHz to 4.0 MHz, 5.3 MHz to 5.4 MHz, 7 MHz to 7.3 MHz, 10.1 MHz to 10.15 MHz, 14 MHz to 14.2 MHz, 18.07 MHz to 18.17 MHz, 21.0 MHz to 21.4 MHz, 24.89 MHz to 24.99 MHz, 28.0 MHz to 29.7 MHz and 50.0 MHz to 54.0 MHz.</p>			

Table 1 Test specifications for ENCLOSURE PORT IMMUNITY to RF wireless communications equipment

Test frequency (MHz)	Band ^{a)} (MHz)	Service ^{a)}	Modulation ^{b)}	Maximum power (W)	Distance (m)	Immunity test level (V/m)
385	380-390	TETRA 400	Pulse modulation ^{b)} 18 Hz	1.8	0.3	27
450	430-470	GMRS 460, FRS 460	FM ^{c)} ± 5 kHz deviation 1 kHz sine	2	0.3	28

710	704-787	LTE Band 13, 17	Pulse modulation ^{b)} 217 Hz	0.2	0.3	9
745						
780						
810	800-960	GSM 800/900, TETRA 800, iDEN 820, CDMA 850, LTE Band 5	Pulse modulation ^{b)} 18 Hz	2	0.3	28
870						
930						
1720	1700-1990	GSM 1800; CDMA 1900; GSM 1900; DECT; LTE Band 1, 3, 4, 25; UMTS	Pulse modulation ^{b)} 217 Hz	2	0.3	28
1845						
1970						
2450	2400-2570	Bluetooth, WLAN, 802.11 b/g/n, RFID 2450, LTE Band 7	Pulse modulation ^{b)} 217 Hz	2	0.3	28
5240	5100-5800	WLAN 802.11 a/n	Pulse modulation ^{b)} 217 Hz	0.2	0.3	9
5500						
5785						

NOTE If necessary to achieve the IMMUNITY TEST LEVEL, the distance between the transmitting antenna and the ME EQUIPMENT or ME SYSTEM may be reduced to 1 m. The 1 m test distance is permitted by IEC 61000-4-3.

a) For some services, only the uplink frequencies are included.

b) The carrier shall be modulated using a 50 % duty cycle square wave signal.

c) As an alternative to FM modulation, 50 % pulse modulation at 18 Hz may be used because while it does not represent actual modulation, it would be worst case.

B.4 Recommended Separation Distances

Recommended separation distances between portable and mobile RF communications equipment and M3

M3 is intended for use in an electromagnetic environment in which radiated RF disturbances are controlled. The customer or the user of M3 can help prevent electromagnetic interference by maintaining a minimum distance between portable and mobile RF communications equipment (transmitters) and M3 as recommended below, according to the maximum output power of the communications equipment.

Rated maximum output power of transmitter (W)	Separation distance according to frequency of transmitter(m)		
	150 kHz to 80 MHz $d = 1.2\sqrt{P}$	80 MHz to 800 MHz $d = 1.2\sqrt{P}$	800 MHz to 2.7 GHz $d = 2.3\sqrt{P}$
0.01	0.12	0.12	0.23
0.1	0.38	0.38	0.73
1	1.2	1.2	2.3
10	3.8	3.8	7.3
100	12	12	23

For transmitters rated at a maximum output power not listed above, the recommended separation distance d in meters (m) can be estimated using the equation applicable to the frequency of the transmitter, where P is the maximum output power rating of the transmitter in watts (W) according to the transmitter manufacturer.

NOTE 1 At 80 MHz and 800 MHz, the separation distance for the higher frequency range applies.

NOTE 2 These guidelines may not apply in all situations. Electromagnetic propagation is affected by absorption and reflection from structures, objects and people.

Appendix C Abbreviation

Abbr	English Full Name/Description
AC	Alternating current
Adu	Adult
Art	Arterial
aVF	Left foot augmented lead
aVL	Left arm augmented lead
aVR	Right arm augmented lead
BC	Burst count
BP	Blood pressure
BTPS	Body temperature and pressure, saturated
CCU	Cardiac care unit
CISPR	International Special Committee on Radio Interference
CMS	Central monitoring system
COHb	Carboxyhemoglobin
CVP	Central venous pressure
DC	Direct current
Des	Desflurane
Dia	Diastolic
ECG	Electrocardiogram
EEC	European Economic Community
EEG	Electroencephalogram
EMC	Electromagnetic compatibility
EMG	Electromyogram
EMI	Electromagnetic interference
Enf	Enflurane
ER	Emergency room
ESU	Electrosurgical unit
EtN ₂ O	End-tidal nitrous oxide
Eto	Ethylene oxide
EtO ₂	End-tidal oxygen

Abbr	English Full Name/Description
FCC	Federal Communication Commission
FDA	Food and Drug Administration
Fi	Fraction of inspired
FiCO ₂	Fraction of inspired carbon dioxide
FiN ₂ O	Fraction of inspired nitrous oxide
FiO ₂	Fraction of inspired oxygen
Hal	Halothane
Hb	Hemoglobin
Hb-CO	Carbon mono-xide hemoglobin
HR	Heart rate
ICP	Intracranial pressure
ICU	Intensive care unit
ID	Identification
IEC	International Electrotechnical Commission
IEEE	Institute of Electrical and Electronic Engineers
Iso	Isoflurane
LA	Left arm
LAP	Left atrial pressure
LCD	Liquid crystal display
LED	Light emitting diode
LL	Left leg
MAP	Mean arterial pressure
MDD	Medical Device Directive
MetHb	Methemoglobin
MRI	Magnetic resonance imaging
N/A	Not applicable
N ₂	Nitrogen
N ₂ O	Nitrous oxide
Neo	Neonate
NICU	Neonatal intensive care unit
NIBP	Non-invasive blood pressure

Abbr	English Full Name/Description
O ₂	Oxygen
OR	Operating room
oxyCRG	Oxygen cardio-respirogram
PA	Pulmonary artery
PACU	Post-anaesthesia care unit
PAWP	Pulmonary artery wedge pressure
Ped	Pediatric
Pleth	Plethysmogram
PR	Pulse rate
PVC	Premature ventricular complex
R	Right
RA	Right arm
RAP	Right atrial pressure
Resp	Respiration
RHb	Reduced hemoglobin
RL	Right leg
RM	Respiration mechanics
RR	Respiration Rate
SEF	Spectral edge frequency
Sev	Sevoflurane
SpO ₂	Pulse Oxygen Saturation
SQI	Signal quality indicator
SR	Suppression ratio
SYS	Systolic pressure
TB	Blood Temperature
TD	Temperature difference
TEMP	Temperature
TP	Total power
USB	Universal serial bus

P/N: 01.54.109395
MPN: 01.54.109395025



EDAN INSTRUMENTS, INC.
#15 Jinhui Road, Jinsha Community, Kengzi Sub-District
Pingshan District, 518122 Shenzhen, P.R.China
Email: info@edan.com.cn
TEL: +86-755-2689 8326 FAX: +86-755-2689 8330
Website: www.edan.com.cn



EC REPRESENTATIVE
Shanghai International Holding Corp. GmbH
Eiffestrasse 80, 20537 Hamburg Germany
TEL: +49-40-2513175
E-mail: shholding@hotmail.com